



Come Experience the Harvest!

Virginia Tech.
VT

23RD ANNUAL

HOKIE HARVEST SALE

FRIDAY, OCTOBER 27, 2017

ANIMAL JUDGING PAVILION • SALE TIME 6:30 PM

VIRGINIA TECH, BLACKSBURG, VIRGINIA

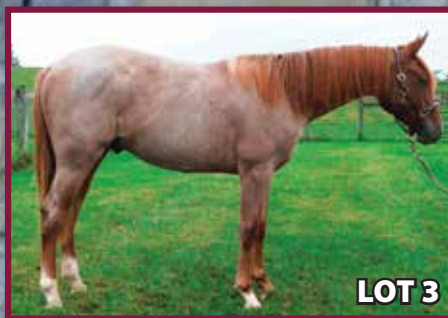



23rd Annual

HOKIE HARVEST SALE

Friday, **OCTOBER 27, 2017**

Animal Judging Pavilion • Blacksburg, VA

Sale Time @ 6:30 pm EDT (Animal Judging Pavilion)

Virginia Tech, Blacksburg, Virginia



SALE DAY PHONES:

Dan Eversole (540) 641-0295

Chad Joines (540) 557-7263

Ken Brubaker (540) 908-5799

Sale Manager:

2017 Livestock Merchandising Class

Ringpersons:

Madalyn Fox, Louisa, VA	Senior	APSC
Randall Gray, Stephens City, VA	Senior	Ag Tech (in sale ring)
Chris Lower, Free Union, VA	Senior	Ag Tech (in sale ring)
Elizabeth Mullins, Clintwood, VA	Sophomore	APSC
Richard Towell, Goochland, VA	Senior	Ag Tech

Sale Clerk:

Lauren Beasley, Bluemont, VA	Junior	AAEC
------------------------------	--------	------

Sale Consultant:

Brubaker Sales and Marketing LLC

Sale Advisor:

Dr. Dan Eversole

Auctioneer:

Cattle: Col. Ken Brubaker, Brubaker Sales & Marketing LLC

Cattle Photography & Video:

High Road Photography, Dr. Dan Eversole, and Mr. Chad Joines
2017 Clipping and Photography Committee

Special Representatives:

Dr. Timothy Sands	President, Virginia Tech
Dr. Alan Grant	Dean, College of Agriculture and Life Sciences
Scott Buchanan	President, Virginia Angus Assn.
John Fleishman	President, Virginia Hereford Assn.
Chad Joines	President, Virginia Simmental Assn.
Jason Carter	Executive Director, Virginia Cattlemen's Assn.
James Bostic	Executive Secretary, West Virginia Cattlemen's Assn.

Publications Representatives:

Chris Jeffcoat	Regional Manager, American Angus Assn.
Tommy Coley	Eastern Region, American Hereford Assn.
Gordon Hodges	Eastern Region Trustee, American Simmental Assn.

**61 BEEF CATTLE and
3 ANGUS EMBRYOS**
(Registered Purebreds and Commercial)

4 purebred spring pair splits
8 fall-calving purebred cows
18 spring-calving commercial cows
and heifers
19 breeding-age bulls

**8 Quarter Horses and 7 Warmbloods
(ONLINE SALE)**
Stock, Performance, and
Sporthorses (AHS, OLD/NA)
Weanlings, Yearlings, and 2-year-olds

Bidding Opens October 1ST and
Closes 6PM October 27TH

AQHA Facebook:
<https://www.facebook.com/SmithfieldHorseCenter>

Warmblood Facebook:
<https://www.facebook.com/MARECenter/>

Equine Auction Site:
<https://horsesales.cals.vt.edu/>

KEN BRUBAKER
5815 N. Valley Pike
Harrisonburg, VA 22802
540/908-5799
ken@brubakersales.com
www.brubakersales.com

Welcome Hokie Friends and Cattlemen,

For the 23rd year Virginia Tech will share their harvest of elite genetics. This is an amazing lineup across multiple breeds that will add true value to your herds. Whether you are looking to add a special cow, herd bull or exceptional commercial females, this offering will afford you that opportunity.



The students have done an exceptional job again this year and have learned all facets of livestock and equine marketing. This is one of the best ag schools in the country and these students are some of the very best and we should be proud of them.

If we can assist you with selection or information, please feel free to contact us. We hope you can attend the sale and look forward to seeing you on October 27th.

*Best regards,
Ken Brubaker*

August 29, 2017

Dear Friends:

It is our pleasure to welcome you to our 23rd Annual Hokie Harvest Sale managed by the 2017 Livestock Merchandising Class and hosted by the Department of Animal and Poultry Sciences at Virginia Tech. This course has been a fantastic experience for us to work with such outstanding undergraduate students over the past 23 years, many of which have become industry leaders and prominent livestock producers.

The Hokie Harvest Sale has developed a significant reputation over the years for selling high quality, university-owned livestock. Our equine faculty and staff here on campus and at the Middleburg Agricultural Research and Extension Center are selling an excellent offering of Quarter Horses and Warmbloods. Please join us as we showcase these well-bred horses from 2-6 PM on sale day. The online auction will be open for bidding on October 1st and will close promptly at 6:00 PM on October 27th. This year's cattle offering again features both purebred and commercial beef cattle along with an Angus embryo package. The Hokie Harvest is more than just a beef cattle or horse sale; it's an exciting, fun-filled day with impressive livestock, outstanding students, great fellowship, and delicious food! Don't miss out on this opportunity to witness our future industry leaders in action.

This production sale is unique to the university and the Commonwealth of Virginia because it has been organized and managed by 71 Virginia Tech students in an experiential learning environment. Both two- and four-year students have gained "hands-on" experience in sale management, budgeting, advertising, cataloging, clerking, and livestock photography. Students have worked extremely hard in the planning and preparation of our production sale, which includes a live auction of 61 head of registered and commercial beef cattle and 15 horses being sold exclusively online at <https://horsesales.cals.vt.edu>

Breeders of purebred Hereford, Simmental, and Angus cattle will be able to select AI-sired progeny and frozen embryos from a cross-section of the VT Beef Cattle herd. Some of our very best females and bulls have been hand-picked stemming from elite donors that combine curve-bending EPDs, breed-changing genetics, and acceptable phenotype. Mature cows with proven production records and promising herd sires from predictable cow families will be sold. All four spring-born calves will sell separately from their dams. A strong set of pregnant commercial cows and heifers will also be offered. Cowbuyer LLC will again provide online bidding for the cattle sale if you are unable to attend but you must register at www.cowbuyer.com at least one hour before the sale in order to watch/bid online in real-time.

The Department of Animal and Poultry Sciences takes great pride in our university, our livestock, and especially our students. We encourage you to 'Come and Experience the Harvest' on Friday, October 27th and get to know this great group of future industry leaders. Funds generated from the Hokie Harvest will continue to provide funding critical to the survival of departmental programs. Many thanks to all of you for your past support and interest in our beef cattle and equine teaching programs. We are committed to making you a satisfied customer and are here to assist you in any way we can.

Sincerely,

Dan Eversole, Director
Beef Cattle ProgramsChad Joines, Director
Beef Cattle Operations***Invent the Future***



SALE HEADQUARTERS:

Beef Cattle Center and Alphin-Stuart Livestock Arena, 500 Plantation Road, Blacksburg, Virginia

BEEF CATTLE:

Dr. Dan Eversole: (540) 231-4738 (o), (540) 641-0295 (cell), deversol@vt.edu

Mr. Chad Joines: (540) 231-6280 (barn office), (540) 557-7263 (cell), cjoines@vt.edu

HORSES:

Ms. Lisa Nulton: (585) 662-3102 (cell), nultonlc@vt.edu

Ms. Beth Boteler: (540) 231-8750 (o), beblackw@vt.edu

Dr. Bridgett McIntosh: (540) 687-3521, Ext 22 (o), bmcintosh@vt.edu

LIABILITY:

All persons who attend the sale do so at their own risk. Neither Sale Management, Virginia Tech, nor any person connected with the sale assume any liability, legal or otherwise, for any accidents that may occur. Students and staff will be available and happy to answer questions about sale animals and present them for inspection. PLEASE DO NOT BRING DOGS ONTO SALE GROUNDS.

INSPECTION:

Cattle are available for inspection at your convenience 10 days prior to the sale.

MAIL OR PHONE BIDS:

Buyers unable to attend the sale may send their bids to Dr. Dan Eversole, Mr. Chad Joines, or the auctioneer, Mr. Ken Brubaker.

TRANSPORTATION:

Blacksburg is easily reached via Interstate 81 and Rt. 460 Bypass. USAir, Delta, Northwest and United Airlines serve the Roanoke-Blacksburg Regional Airport.

LODGING ACCOMMODATIONS:

Holiday Inn University.....	(540) 552-7001
Hilton Garden Inn.....	(540) 552-5005
Holiday Inn Express & Suites.....	(540) 552-5636
The Inn at Virginia Tech	(540) 231-8000

SALE DAY ACTIVITIES:

2:00 – 6:00 pm.....	Horse Sale Showcase in Campbell Arena
3:00 – 7:00 pm.....	Buyer Registration in the Beef Cattle Barn
4:30 – 6:30 pm.....	Complimentary Barbecue Dinner in the Alphin-Stuart Arena
6:30 pm	Cattle Sale – Animal Judging Pavilion

FOR MORE PICTURES, VIDEOS, AND DETAILS:

<https://ext.vt.edu/agriculture/beef-cattle.html>
www.cowbuyer.com
<https://horsesales.cals.vt.edu/>

TERMS & CONDITIONS:

Cattle sell under the Standard Terms and Conditions as suggested by the American Hereford Association, American Angus Association, and the American Simmental Association. Cash or good check will be accepted. All purchases are to be settled for at the conclusion of the sale and will remain at the VT Beef Center until proper settlement is made.

REGISTRATIONS & TRANSFER:

Registration certificates will be transferred to the buyer at the seller's expense. Buyers must provide full name and address for transfer. Association member codes would be helpful if you are a member of a purebred breed association; however, this is not required to purchase cattle. Animal transfers will be done after settlement.

HEALTH REQUIREMENTS:

1. All cattle for sale will meet the health requirements of the Commonwealth of Virginia and appropriate health papers will be furnished for interstate shipment. Every female (4-12 mo.) has been calf-hood vaccinated for Brucellosis. All cattle are from a Brucellosis certified-free herd (No. 1498) and Tuberculosis accredited-free herd (No. 2174) and are tested-free of Johnes, Anaplasmosis, and Bovine Leukosis.
2. If sale cattle are returned to the seller for an adjustment, they must meet health requirements of the Commonwealth of Virginia.
3. Yearling bulls have undergone a breeding soundness examination (BSE) and are considered satisfactory breeders as defined by the Society of Theriogenology. Buyers will be given a copy of the BSE results.

BREEDING GUARANTEE:

Bulls are guaranteed to be breeders for one breeding season (defined as the ability to settle healthy cows by the time they are 14 months of age) with exception of:

- a. Injury or disease occurring to the animal after time of purchase.
- b. Gross negligence or willful misconduct on the part of the purchaser.

HERD HEALTH:

All pregnant females were given a pre-breeding vaccine which consisted of a modified-live virus IBR-PI3, BVD, BRSV, and a 5-way Lepto bacterin. Any questions concerning general herd health can be directed to Dr. Terry Swecker, College of Veterinary Medicine (0442), Virginia Tech, Blacksburg, VA 24061, 540/231-7375.

ANNOUNCEMENTS:

Announcements from the auction block will take precedence over printed material in this sale book. Virginia Tech reserves the right to withdraw any sale lot from the sale that does not meet their specifications prior to the sale.

EPDs represented in this sale book were current at the time requested for the layout and printing of this sale book. EPDs are recalculated throughout the year by the respective breed associations, which mean the figures represented in this book may change for these animals in the future.



Registration is required. Please register at least one (1) hour prior to sale time at www.cowbuyer.com



CARRIE B JOINES

VPI Shadoe 1Y28 - Donor Dam of Lot 1
 DOB: 9/01/11 Angus Reg#: 17223391 Simmental Reg#: 2690182



Jindra Acclaim
 Angus Sire of Lot 1

Jindra 3rd Dimension
Jindra Acclaim
 17972810 + Jindra Blackbird Lassy 1111

Jindra Double Vision
 Jindras Sapphire J 417
 # Connealy Impression
 Jindras Enchantress J 102
 #+ G A R Grid Maker
 S A V Abigale 0451
 #+ S A F 598 Bando 5175
 + Champion Hill Shadoe 1357

#+ S A V Bismarck 5682 [RDF]
VPI Shadoe 1Y28
 17223391 + Shadoe 1062 of Foxcross

		S		D		\$W	\$W
		MARB	MARB	RE	RE	\$F	\$F
		+0.67	+0.51	+0.89	+0.38	+166.05	+66.60
S	+11 .53	+2 .77	+84 .71	+162 .59	+26 .26	+41.50	+30.07
		FAT	FAT	\$B	\$B		
D	+11 .36	+6 .53	+56 .47	+98 .43	+30 .38	+217.32	+126.42

- ▶ **Selling 3 grade 1 embryos with a guarantee of 1 pregnancy if transferred by a certified technician.**
- ▶ This is a unique opportunity to acquire genetics from one of the elite Donor cows in the VT program. VPI Shadoe 1Y28 is a phenotypically flawless cow with length of spine, base width, depth of rib and volume with a beautiful udder.
- ▶ "1Y28" has excelled in production with Angus progeny WR 2@106, YR 2@101, and RE of 102 on 2 head.
- ▶ She has the unique ability to blend calving-ease, maternal and growth traits to add value to these embryos.
- ▶ Within the Angus breed, she ranks in the elite 10% on CED and top 15% on WVEPD and YVEPD. She ranks in the elite 4% on \$W, 10% on \$F, and 20% on \$B.
- ▶ In the Simmental herdbook, her natural progeny WR is 2/110.
- ▶ The mating to Jindra Acclaim adds greater Angus breed rank value to the resulting progeny.
- ▶ "Acclaim" ranks in the elite 1% of the breed on WVEPD, YVEPD, \$F and \$B, while blending calving-ease and a REEPD at 3% and \$W at 2%.

2 VPI TONI 5C6

Calved: 01/16/2015		Cow 18161845		Tattoo: 5C6		\$W	
# C R A Bextor 872 5205 608		# B A R Ext Traveler 205		MARB		+\$54.81	
G A R Prophet		Cra Lady Jaye 608 498 S Easy		+ .72		+\$50.77	
+16295688 + G A R Objective 1885		# S S Objective T510 0T26		RE		+\$G	
#+ S A V Bismarck 5682 [RDF]		G A R 1407 New Design 2232		+ .40		+\$41.44	
VPI Toni 2Z9		#+ G A R Grid Maker		FAT		+\$B	
17262707 # B&B Toni 903		S A V Abigale 0451		+ .015		+\$92.71	
		# Whitestone Widespread MB		CED		+8 .36	
		B&B Toni 605		BW		+3.3 .52	
				WW		+66 .46	
				YW		+109 .42	
				Milk		+19 .35	

- ▶ Examined safe to S Whitlock 179, due 1/26/18.
- ▶ High growth, high carcass daughter of "Prophet" from the "Toni" cow family at VT.
- ▶ She ranks in the elite 3% on WVEPD and 5% on YWEPD.
- ▶ Her \$Values place her in the top 15% on \$W, \$G, and \$QG.



VPI Toni 5C6 - Lot 2

2A VPI TONI 7E3

Calved: 01/07/2017		Cow 18796931		Tattoo: 7E3		\$W	
Barstow Cash		# Sitz Dash 10277		MARB		+\$52.87	
Barstow Bankroll B73		Barstow Queen W16		+ .59		+\$69.15	
18036327 Barstow Miss Dianna Z25		# CAR Efficient 534		RE		+\$G	
+ G A R Prophet		# Barstow Miss Dianna X128		+ .52		+\$38.16	
VPI Toni 5C6		# C R A Bextor 872 5205 608		FAT		+\$B	
18161845 VPI Toni 2Z9		+ G A R Objective 1885		- .002		+\$121.39	
		#+ S A V Bismarck 5682 [RDF]		CED		+11 .23	
		# B&B Toni 903		BW		+7 .32	
				WW		+62 .28	
				YW		+116 .18	
				Milk		+21 .10	

- ▶ Sells Open
- ▶ High growth daughter of the Lot 2 cow.
- ▶ Sired by "Bankroll" who has been one of the more popular bulls of the 2017 breeding season.
- ▶ She has a balanced EPD profile that blends growth and calving-ease.



Barstow Bankroll B73 - Sire of Lots 2A and 6A

3 VPI SAVANNAH 4B19

Calved: 08/31/2014		Cow 18051685		Tattoo: 4B19		\$W	
# Mytty In Focus [RDF]		# S A F Focus of E R		MARB		+\$61.62	
A A R Ten X 7008 S A		Myyty Countess 906		+1.06		+\$67.76	
#15719841 # A A R Lady Kelton 5551		S A V Adaptor 2213		RE		+\$G	
# S S Objective T510 0T26		+ H S A F Lady Kelton 504B		+ .43		+\$46.84	
VPI Savannah 0X33		# S S Traveler 6807 T510		FAT		+\$B	
16932322 + VPI 5899 Predestined 8U44		S S Miss Rita R011 7R8		+ .010		+\$146.69	
		# G A R Predestined		CED		+10 .26	
		VT Future Direction B49		BW		+9 .37	
				WW		+64 .33	
				YW		+113 .31	
				Milk		+27 .25	

- ▶ Examined safe to HA Cowboy Up 5405, due 1/26/18.
- ▶ An own daughter of "Ten X" who led the breed in registrations for multiple years.
- ▶ She is a daughter of one of the highly productive cows in the program, as her dam has a progeny WR 5@112, YR 5@105, IMF 4@109, and REA 4@105.
- ▶ Her genetic EPD profile places her at the top of the breed on multiple traits. She ranks in the elite 2% on \$QG, 3% on YWEPD, and 4% on WVEPD. She ranks in the top 5% on \$B and 10% on \$W, \$F, and \$G.



AAR Ten X 7008 SA - Sire of Lot 3

3A VPI SAVANNAH 7E1

Calved: 01/04/2017		Cow 18793075		Tattoo: 7E1		\$W	
B/R Future Direction 4268		# C A Future Direction 5321		MARB		+\$57.22	
WR Journey-1X74		B/R Ruby 9114		+ .92		+\$56.33	
+16924332 2 Bar 5050 New Design 7831		#+ G A R New Design 5050		RE		+\$G	
# A A R Ten X 7008 S A		2 Bar 036 Lady 0107		+ .69		+\$48.21	
VPI Savannah 4B19		# Mytty In Focus [RDF]		FAT		+\$B	
18051685 VPI Savannah 0X33		# A A R Lady Kelton 5551		+ .011		+\$142.95	
		# S S Objective T510 0T26		CED		+12 .26	
		+ VPI 5899 Predestined 8U44		BW		-6 .33	
				WW		+57 .29	
				YW		+99 .23	
				Milk		+27 .11	

- ▶ Sells Open
- ▶ Wonderful phenotype in this "Journey" daughter that blends that style and class with breed ranking.
- ▶ She blends low birth with a high CED at +12 with \$values in the top 10% in \$G, \$QG, and top 15% on \$B.



WR Journey 1X74 - Sire of Lot 3A

4 VPI VICTRA A303

Calved: 01/20/2013		Cow P43379849		Tattoo: A303		BMI\$	
THM DURANGO 4037 (CHB,SOD,DLF,HYF,IEF)		CS BOOMER 29F (SOD,DLF,HYF,IEF)		MARB		+\$ 14	
CRR ABOUT TIME 743 (CHB,SOD,DLF,HYF,IEF)		THM 7085 VICTRA 9036 (DLF,HYF,IEF)		+0.01		+\$ 14	
P42797564 CRR D03 CASSIE 206 (DLF,HYF,IEF)		SHF INTERSTATE 20X D03 (SOD,CHB,DLF,HYF,IEF)		RE		BIIS	
BTF CONNECTION 540 5048		CRR 475E CASSIE 838 (P41070802)		+0.29		+\$ 12	
THM 5048 VICTRA 3222		NT PLATO RUPERT 0590		FAT		CHBS	
42550623 THM PM DOMINETTE 1210		AF VICTORIA 69R 635 (DOD)		-0.041		+\$ 24	
		HRP VICTOR 109W 9322		CED		BW	
		MISS LONGBRANCH 16J W864		+1.2		.18	
				+4.1		.29	
				+47		.24	
				+75		.24	
				+25		.22	

- ▶ Examined safe to KT Small Town Kid 5051, due 1/26/18.
- ▶ This is an elite top-producing cow in the VT program with a progeny WR 2@101 and YR 2@102.
- ▶ Her dam has been a long-lived cow in the herd with a progeny WR 8@96, YR 4@97 and IMF of 103 on 4 head.
- ▶ She expresses an EPD profile at or above average on multiple traits that are balanced for maternal, growth, and carcass.



VPI Victra A303 - Lot 4

4A VPI HOMETOWN E705

Calved: 01/29/2017		Bull P43811227		Tattoo: E705		BMI\$	
SHF WONDER M326 W18 ET (CHB,DLF,HYF,IEF)		KCF BENNETT 3008 M326 (CHB,SOD,DLF,HYF,IEF)		MARB		+\$ 20	
NJW 735 W18 HOMETOWN 10Y ET (CHB,DLF,HYF,IEF)		SHF GOVERNESS 236G L37 (DLF,HYF,IEF)		+0.22		+\$ 17	
P43214853 NJW P606 72N DAYDREAM 735 (DLF,HYF,IEF)		PW VICTOR BOOMER P606 (SOD,DLF,HYF,IEF)		RE		BIIS	
CRR ABOUT TIME 743 (CHB,SOD,DLF,HYF,IEF)		NJW 94J DEW 72N (DLF,HYF,IEF)		+0.48		+\$ 16	
VPI VICTRA A303		THM DURANGO 4037 (CHB,SOD,DLF,HYF,IEF)		FAT		CHBS	
P43379849 THM 5048 VICTRA 3222		CRR D03 CASSIE 206 (DLF,HYF,IEF)		-0.003		+\$ 29	
		BTF CONNECTION 540 5048		CED		BW	
		THM PM DOMINETTE 1210		+3.3		.19	
				+2.9		.33	
				+51		P+	
				+85		P+	
				+32		P+	

- ▶ Here is your next herd sire. He is sired by the powerful "Hometown" and out of the productive Lot 4 cow.
- ▶ His EPD profile expresses high growth on WW and YW and low birth for trouble-free production.



NJW 735 W18 Hometown 10Y ET - Sire of Lots 4A, 12A, 22, 24, and 26

Hokie Simmental Spring Pair Split

5 VPI POLLY ANNA C560 ET

Calved: 02/01/2015		Cow 2991657		Tattoo: C560		MARB	
ELLINGSON LEGACY M229		NICHOLS LEGACY G151		-0.08		RE	
MR NLC UPGRADE U8676		ELLINGSON MS PSTOCK K58		0.99		API	
2474338 MS NLC MOJO S6119 B		GLS MOJO M38		FAT		TI	
PVF-BF BF26 BLACK JOKER		GFI DARLA M410		-0.107		67.2	
KDG POLLY ANNA P89		HARTS BLACK CASINO B408		CED		BW	
2278258 BIF H808		PVF-BF MABELLE C131		8.3		0.28	
		BLACK IRISH KANSAS		0.5		0.29	
		BIF MISS MARCH E984		64.4		0.27	
				96.7		0.27	
				24.5		0.27	

- ▶ Examined safe to Hook's Yellowstone 97Y, due 1/26/18.
- ▶ Purebred Simmental, Homozygous Polled, Heterozygous Black
- ▶ This first-calf heifer has done an exceptional job with her first calf as evident by her Lot 5A heifer.
- ▶ She expresses above-average growth and ranks in the elite 1% on YG.



Mr NLC Upgrade U8676 - Sire of Lot 5

5A VPI POLLY ANNA E768

Calved: 02/11/2017		Cow 3253599		Tattoo: E768		MARB	
CCR CATALYST 7035W		S A V FINAL ANSWER 0035		0.46		RE	
CCR SPARTAN 9124A		CCRMS1043OFFPREC1023 7035		0.78		API	
2725682 CCR MS APPLE 9332W		HTP SVF IN DEW TIME		FAT		TI	
MR NLC UPGRADE U8676		CCR 992F FULLHOUSE 3249N		-0.034		78.8	
VPI POLLY ANNA C560 ET		ELLINGSON LEGACY M229		CED		BW	
2991657 KDG POLLY ANNA P89		MS NLC MOJO S6119 B		8.5		0.20	
		PVF-BF BF26 BLACK JOKER		0.5		0.34	
		BIF H808		71.9		0.31	
				107.0		0.20	
				24.9		0.17	

- ▶ Sells Open
- ▶ 3/4 SM 1/4 AN, Homozygous Polled, Homozygous Black
- ▶ This stylish SimAngus heifer has all the credentials to mature into a highly valued brood cow.
- ▶ She ranks in the top 10% on WW and 15% on YW.



6 VPI SAZERAC 5C23

6	Calved: 09/03/2015	Cow 18239538	Tattoo: 5C23	\$W							
# A A R Ten X 7008 S A	# Mytty In Focus [RDF]			+59.97							
Deer Valley All In	# A A R Lady Kelton 5551	MARB	\$F								
17307074 + Deer Valley Rita 0274	# Sitz Upward 307R	+ .39	+99.03								
# G A R Predestined	G A R Objective 2345	RE	\$G								
VPI Predestined 8U45	# B/R New Design 036	+ .83	+35.03								
+16382508 + VT Grid Maker B1	#+ G A R Ext 4206	FAT	\$B								
	#+ G A R Grid Maker	- .050	+162.28								
	+ G A R Precision 100										
		CED	BW	WW	YW	Milk					
		-1	.36	+5.0	.53	+81	.47	+135	.43	+17	.34

- ▶ **Sells with her 8/23/17 herd sire prospect by Barstow Bankroll B73.**
- ▶ This first-calf heifer hails from one of the top-producing cows in the VT program.
- ▶ Her dam posts a progeny WR 6@109, YR 4@107, and IMF of 109 on 4 head.
- ▶ She expresses elite breed rank at 1% on WWEPD and YW EPD, as well as 2% on \$F and 4% on \$B.
- ▶ She has a highly marketable and popular pedigree of recent bloodlines to add more value to your program.



Deer Valley All In - Sire of Lot 6

7 VPI BLACKBIRD 4B20

7	Calved: 08/31/2014	Cow 18051677	Tattoo: 4B20	\$W							
# Mytty In Focus [RDF]	# S A F Focus of E R			+49.35							
A A R Ten X 7008 S A	Mytty Countess 906	MARB	\$F								
#15719841 # A A R Lady Kelton 5551	S A V Adaptor 2213	+ .87	+54.57								
#+ G A R New Design 5050	+ H S A F Lady Kelton 504B	RE	\$G								
VPI Blackbird 0X11	# B/R New Design 036	+ .65	+46.39								
17230957 VPI Blackbird 7T20	G A R Precision 706	FAT	\$B								
	#+ S A F Strategy 9015	+ .013	+138.26								
	# V P I Blackbird 1L40										
		CED	BW	WW	YW	Milk					
		+7	.25	+1.4	.37	+53	.33	+97	.30	+22	.25

- ▶ **Sells with her 8/26/17 herd sire prospect by Spring Cove Paygrade 5064.**
- ▶ A daughter of "Ten X" who led registrations in the Angus breed for multiple years.
- ▶ She ranks in the top 10% of the breed on \$G, \$QG, and \$B, as well as Marb and RE.
- ▶ She blends growth and carcass to add value to your program.
- ▶ Her highly productive dam posts a progeny WR of 4@104, YR 4@103, RE 4@104, and IMF of 103 on 1 head.



AAR Ten X 7008 S A - Sire of Lots 3 and 7

8 VPI MISS ADVANCE 4B21

8	Calved: 09/14/2014	Cow 18051673	Tattoo: 4B21	\$W							
EXAR Upshot 0562B	# Sitz Upward 307R			+54.76							
EXAR Denver 2002B	#+ EXAR Barbara T020	MARB	\$F								
17160560 + Exar Royal Lass 1067	# EXAR 263C	+ .76	+74.91								
# S S Rito Rito R011 2R12	BR Royal Lass 19-132	RE	\$G								
VPI Miss Advance 8U21	S S Rito Rito R76 R011	+ .44	+40.53								
16391693 VPI Miss Advance 6552	# S S Miss Traveler T510 9T22	FAT	\$B								
	# Hyline Right Time 338	+ .013	+138.98								
	V P I Miss Advance 9J25										
		CED	BW	WW	YW	Milk					
		+7	.25	+2.8	+3	+62	.32	+111	.30	+30	.21

- ▶ **Sells with her 8/30/17 herd sire prospect by S Whitlock 179.**
- ▶ She is a daughter of the highly popular "Denver" and expresses above-average breed rank on multiple traits.
- ▶ She ranks among the top 10% of current dams on YWEPD and \$F. She also ranks high on WWEPD, \$B, and \$W.



EXAR Denver 2002B - Sire of Lot 8

9 VPI LADY BURGESS 3A35

9	Calved: 10/12/2013	Cow 17622472	Tattoo: 3A35	\$W							
Connealy Tobin	# Bon View New Design 208			+44.33							
Connealy Confidence 0100	Delia of Conanga 667	MARB	\$F								
16761479 Becka Gala of Conanga 8281	# Connealy Thunder [RDF]	+ .62	+52.89								
# S S Objective T510 0T26	Becka Lee of Conanga 37	RE	\$G								
VPI Objective 8U40	# S S Traveler 6807 T510	+ .37	+33.72								
+16382506 + VT 1407 New Design B4	S S Miss Rita R011 7R8	FAT	\$B								
	# Bon View New Design 1407 [RDF]	+ .042	+106.21								
	+ G A R Expectation 461										
		CED	BW	WW	YW	Milk					
		+15	.26	+1	.38	+51	.34	+96	.31	+18	.28

- ▶ **Sells with her 8/19/17 herd sire prospect by Deer Valley Old Hickory.**
- ▶ Balanced young cow in the prime of her productive years. She has been a solid producer with high fertility as she posts a 337-day calving interval.
- ▶ Her EPD profile stacks her among the above-average active dams in the breed. Trouble-free production from this cow as she ranks in the elite 1% on CED.



VT 1407 New Design B4 - Maternal Grand Dam of Lot 9



10 VPI BLACKBIRD 3A19

Calved: 08/26/2013	Cow 17622474	Tattoo: 3A19	\$W
Connealy Tobin			+41.90
Connealy Confidence 0100			\$F
16761479	Becka Gala of Conanga 8281	# Bon View New Design 208 Delia of Conanga 667	+0.05
		# Connealy Thunder [RDF]	\$G
		Becka Lee of Conanga 37	+0.77
	# B/R New Day 454	#+ Boyd New Day 8005	\$B
VPI Blackbird 0X17		B/R Ruby 1224	+0.014
16932325	VPI Blackbird 6548	# S S Objective T510 0T26	+79.55
		+ VPI Blackbird 4P23	
CED	BW	WW	YW
+15	.26	-1.5	.38
+41	.34	+77	.31
+23	.27		



Connealy Confidence 0100 - Sire of Lots 9 and 10

- **Sells with her 8/19/17 heifer calf by Deer Valley Old Hickory.**
- She is a low-birth moderate growth daughter of "Confidence" who has been widely accepted as a sire of very functional and top-producing females in the breed.
- This cow exhibits low-birth for trouble-free production with a +15 CED and a -1.5 BW EPD.



11 VPI MISS AMBUSH 1Y3

Calved: 01/17/2011	Cow 16968668	Tattoo: 1Y3	\$W
# Rockn D Ambush 1531			+34.84
B/R Ambush 28			\$F
#14188956	+ B/R Ruby of Tiffany 8250	# Paramount Ambush 2172 MS Blackcap Band of R D 1301	+1.02
		# N Bar Emulation EXT	\$G
		B/R Ruby of Tiffany 5113	+0.79
	# S S Objective T510 0T26	# S S Traveler 6807 T510	\$B
G A R Objective 936		S S Miss Rita R011 7R8	-0.032
15463660	+ G A R 1407 New Design N94	# Bon View New Design 1407 [RDF]	+146.48
		+ G A R Precision 4560	
CED	BW	WW	YW
+10	.25	+2.3	.32
+57	.29	+100	.27
+13	.30		



B/R Ambush 28 - Sire of Lot 11

- **Sells with her 8/20/17 herd sire prospect by BSF Hot Lotto 1401.**
- She is an elite daughter of B/R Ambush 28 and stacks a pedigree full of the breed's leading performance sires in recent years.
- She ranks among the elite 1% of active dams in the breed for \$G, upper 3% on SQG, \$YG, Marbling, and RE. She blends that leading status with a top 5% rank on \$B and top 15% on WWEPD and YWEPD.
- She has weaned 2 progeny with an IMF ratio of 122. A son sells as Lot 18 and a grandson sells as Lot 20 in this sale.

Hokie Hereford Fall Pairs



12 VPI MILLIE B412

Calved: 09/04/2014	Cow P43552711	Tattoo: B412	BMI\$
CS BOOMER 29F {SOD,DLF,HYF,IEF}			+\$ 21
THM DURANGO 4037 {CHB,SOD,DLF,HYF,IEF}			CEZ\$
P42460503	THM 7085 VICTRA 9036 {DLF,HYF,IEF}	REMITALL BOOMER 46B {SOD,DLF,HYF,IEF}	+0.22
		CS MISS 1ST FLAG 21A {DOD,DLF,IEF}	+\$ 19
		THM VICTOR DOM 7085	RE
	SCHU-LAR 5N OF 9L 3008 {CHB,SOD,DLF,HYF,IEF}	THM VICTRA 5404 7073	+0.05
VPI MILLIE S617		RRH MR FELT 3008 {CHB,SOD,DLF,HYF,IEF}	+\$ 17
P42761389	RH BENNE H119 MISS M 39	SCHU-LAR 9L OF 1F 821C	FAT
		KCF BENNETT 774 H119 {HYF}	-0.030
		SHR LADY MILLIE J247	+\$ 29
CED	BW	WW	YW
+5.1	.20	+2.1	.39
+50	.32	+89	.34
+17	.23		



THM Durango 4037 - Sire of Lot 12

- **Sells with her 9/26/17 herd sire prospect, Lot 12A, by NJW 735 W18 Hometown 10Y ET.**
- Young "Durango" daughter that will afford you a lifetime of trouble-free production.
- She ranks above breed average on multiple traits and most notably in the elite 1% on Milk, upper 2% on CEZ, and top 20% on YW.
- She will provide added growth and maternal strength to the most discriminating program.



13 VPI MILLIE B405

Calved: 08/29/2014	Cow P43552688	Tattoo: B405	BMI\$
SHF RIB EYE M326 R117 {CHB,SOD,DLF,HYF,IEF}			+\$ 26
BOYD WORLDWIDE 9050 ET {DLF,HYF,IEF}			CEZ\$
P42982024	MSU TCF RACHAEL 225 ET	KCF BENNETT 3008 M326 {CHB,SOD,DLF,HYF,IEF}	+0.33
		HVH MISS HUDSON 83K 8M	+\$ 24
		FELTONS LEGEND 242 {SOD,HYF}	RE
		MSU TCF RACHAEL ET 54N {DLF,HYF,IEF}	+0.12
	UPS DOMINO 3027 {CHB,SOD,DLF,HYF,IEF}	CL 1 DOMINO 9126J 1ET {SOD,CHB,DLF,IEF}	+\$ 21
VPI MILLIE Z215		UPS MISS DIAMOND 1353 {DLF,HYF,IEF}	FAT
P43324697	VPI MILLIE X014	FIELDS EDGE CHISEL 7C4 {DLF,HYF,IEF}	+0.009
		VPI MILLIE S617	+\$ 30
CED	BW	WW	YW
+8.8	.19	-0.5	.39
+50	.32	+77	.33
+29	.20		



Boyd Worldwide 9050 ET - Sire of Lot 13

- **Sells with her 9/3/17 herd sire prospect by KT Small Town Kid 5051.**
- Here is an elite young cow by "Worldwide" that will add great value based on her breed rankings.
- She ranks well above breed average on multiple traits and most notably in the elite 1% on CED, Milk, and CEZ. She blends that with a top 2% ranking on BMI and upper 5% on BI and CHB.
- She hails from the "Millie" cow family that has produced many of the good ones in the VT program.



14 VPI CONVERSATION 6D23 ISOK

Calved: 09/02/2016		Bull 18558017		Tattoo: 6D23		\$W	
Silveiras Conversion 8064		#+ BT Crossover 758N		MARB		+77.54	
SAC Conversation		+ EXG Saras Dream S609 R3		RE		\$F	
17808532 # Lafllins Farrah 0252		#+ S A V 004 Predominant 4438		+ .75		+76.77	
# LCC New Standard		Lafllins Farrah 7215		RE		\$G	
VPI 1Y29 Rita 3A16		# Bon View New Design 1407 [RDF]		+ .39		+30.87	
17622460 VPI 6S31 Rita 1Y29		LCC Sunset K3118		FAT		\$B	
		# SydGen Mandate 6079		+ .051		+153.16	
		VPI Rita 317 6S31		CED		BW	
				+10 .34		+1.0 .52	
				+63 .46		+113 .39	
				+41 .28		Milk	
				WW		YV	
				+63 .46		+113 .39	
				+41 .28		Milk	
				IMF		REA	
				3.9		13.1	
				FAT		0.20	
				SCROTAL		39.0	

- **Heifer Bull**
- Calving-ease bull with curve-bending power and performance. He developed from a 72 lb. BW to wean an impressive 824 lbs. and 1258 lbs. as a yearling.
- He will add carcass quality with a big REA and high marbling score.
- His dam is one of the good young cows in the VT program with a progeny WR 2@108, YR 1@102, and an IMF ratio of 102 on 1 head.
- He ranks among the top 10% of non-parent sires on \$B and the leading 15% on WWEPD and YWEPD.



VPI Conversation 6D23 - Lot 14



15 VPI ABSOLUTE 6D22 ISOK

Calved: 09/02/2016		Bull 18558016		Tattoo: 6D22		\$W	
# S A V Final Answer 0035 [RDF]		# Sitz Traveler 8180		MARB		+67.88	
K C F Bennett Absolute		S A V Emulous 8145		RE		\$F	
16430795 Thomas Miss Lucy 5152		#+ Wulffs Ext 6106		+1.00		+77.17	
# S S Objective T510 0T26		Thomas Miss Lucy 3050		RE		\$G	
VPI Savannah 0X33		# S S Traveler 6807 T510		+ .48		+43.71	
16932322 + PI 5899 Predestined 8U44		S S Miss Rita R011 7R8		FAT		\$B	
		# G A R Predestined		+ .025		+155.07	
		VT Future Direction B49		CED		BW	
				+11 .37		+1.0 .54	
				+67 .48		+116 .41	
				+23 .35		Milk	
				WW		YV	
				+67 .48		+116 .41	
				+23 .35		Milk	
				IMF		REA	
				3.4		14.2	
				FAT		0.32	
				SCROTAL		38.0	

- **Heifer Bull**
- With a double-digit CED, 77 lb. BW, and BWEPPD +1.0, he has all the credentials to provide trouble-free calving.
- You will not sacrifice pounds with this bull. He smashed the scales at both weaning and yearling to ratio 109 and 103, respectively. He will afford you easy calving with pounds-heavy calves to pay-up at weaning.
- Note the carcass quality. He is high in marbling and has a huge 14.2 REA.
- He ranks in the top 10% on \$B, WWEPD, YWEPD, \$W, \$F, Marbling and \$QG. He ranks among non-parent bulls in the leading 15% on CED.



VPI Absolute 6D22 - Lot 15



16 VPI CONVERSATION 6D26 ET ISOK

Calved: 09/03/2016		Bull +18787627		Tattoo: 6D26		\$W	
Silveiras Conversion 8064		#+ BT Crossover 758N		MARB		+60.67	
SAC Conversation		+ EXG Saras Dream S609 R3		RE		\$F	
17808532 # Lafllins Farrah 0252		#+ S A V 004 Predominant 4438		+ .80		+32.41	
# G A R Prophet		Lafllins Farrah 7215		RE		\$G	
VPI 7T39 Rita 2Z18		# C R A Bextor 872 5205 608		+ .67		+40.93	
17338644 + VPI Rita 317 7T39 ET		+ G A R Objective 1885		FAT		\$B	
		# G A R Predestined		+ .060		+107.23	
		+ HHF Alli Rita 704 317		CED		BW	
				+5 .32		+1.7 .47	
				+53 .41		+87 .37	
				+27 .26		Milk	
				WW		YV	
				+53 .41		+87 .37	
				+27 .26		Milk	
				IMF		REA	
				4.6		12.7	
				FAT		0.23	
				SCROTAL		36.0	

- **Heifer Bull**
- He is a product of the ET program at VT.
- His Donor dam is a special young cow that traces to the long-time VT \$10,000 valued Donor, "Rita 317", who has been an important cow yielding numerous elite progeny.
- This bull will produce low-birth calves that perform at profitable levels.
- Flush brother sells as Lot 17.

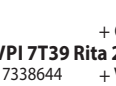

17 VPI CONVERSATION 6D27 ET ISOK

Calved: 09/04/2016		Bull +18787628		Tattoo: 6D27		\$W	
Silveiras Conversion 8064		#+ BT Crossover 758N		MARB		+60.41	
SAC Conversation		+ EXG Saras Dream S609 R3		RE		\$F	
17808532 # Lafllins Farrah 0252		#+ S A V 004 Predominant 4438		+ .65		+62.99	
# G A R Prophet		Lafllins Farrah 7215		RE		\$G	
VPI 7T39 Rita 2Z18		# C R A Bextor 872 5205 608		+ .42		+34.46	
17338644 + VPI Rita 317 7T39 ET		+ G A R Objective 1885		FAT		\$B	
		# G A R Predestined		+ .039		+125.54	
		+ HHF Alli Rita 704 317		CED		BW	
				+6 .33		+1.7 .48	
				+60 .42		+102 .38	
				+21 .27		Milk	
				WW		YV	
				+60 .42		+102 .38	
				+21 .27		Milk	
				IMF		REA	
				2.8		12.5	
				FAT		0.18	
				SCROTAL		35.0	

- **Heifer Bull**
- Flush brother to Lot 16.
- Note the curve-bending performance in this bull. He started at 56 lbs. and weaned at nearly 700 lbs.
- His Donor dam is a great young cow in the program and weaned her first calf with a 106 ratio and traces to the \$10,000 valued long-time VT Donor, "Rita 317".



SAC Conversation - Sire of Lots 14, 16, 17, and 18

18 VPI CONVERSATION 6D20

Calved: 09/02/2016 Bull 18558015 Tattoo: 6D20

Silveiras Conversion 8064 #+ BT Crossover 758N
 SAC Conversation # Laffins Farrah 0252 #+ S A V 004 Predominant 4438
 #+ B/R Ambush 28 # Rockn D Ambush 1531
 VPI Miss Ambush 1Y3 + B/R Ruby of Tiffany 8250
 +16968668 G A R Objective 936 # S S Objective T510 0T26
 + G A R 1407 New Design N94

\$W	+46.88
\$F	\$F
MARB	+56
RE	\$G
FAT	+1.13
\$B	+43.63
\$B	-0.21
\$B	+160.02

CED	BW	WW	YW	Milk
+7	.34	+2.7	.52	+63
		.46	+117	.38
				+20
				.28

BW	AWW	RATIO	AYW	RATIO	IMF	REA	FAT	SCROTAL
70	675	95	1169	98	3.0	15.3	0.17	39.0

- ▶ **Low Birth Weight**
- ▶ This bull will add growth and carcass to increase the value of your next calf crop.
- ▶ Note this bull's huge REA of 15.3 to add to your calves value.
- ▶ He ranks in the elite 1% on REEPD, 3% on \$YG, and top 5% on \$B.
- ▶ He ranks among the leading 10% of non-parent bulls on \$F and YWEPD and 15% on WWEPD.
- ▶ He tipped the scales at weaning at 675 lbs. and nearly 1200 lbs. as a yearling.
- ▶ He is lean, and athletic, and ready to breed.



19 VPI ABSOLUTE 6D10

Calved: 08/21/2016 Bull 18558011 Tattoo: 6D10

S A V Final Answer 0035 [RDF] # Sitz Traveler 8180
 K C F Bennett Absolute S A V Emulous 8145
 16430795 Thomas Miss Lucy 5152 #+ Wulffs Ext 6106
 Thomas Miss Lucy 3050
 # A A R Ten X 7008 S A # Mytty In Focus [RDF]
 VPI Blackbird 4B20 # A A R Lady Kelton 5551
 18051677 VPI Blackbird 0X11 #+ G A R New Design 5050
 VPI Blackbird 7T20

\$W	+47.14
\$F	\$F
MARB	+68
RE	\$G
FAT	+69
\$B	+38.29
\$B	+0.42
\$B	+132.92

CED	BW	WW	YW	Milk
+12	.36	-.4	.53	+53
		.47	+97	.40
				+16
				.33

BW	AWW	RATIO	AYW	RATIO	IMF	REA	FAT	SCROTAL
65	643	90	1128	94	3.1	12.5	0.23	37.5

- ▶ **Heifer Bull**
- ▶ With a 65 lb. BW, a high CED, and low BWEPD, this bull classifies as a trouble-free, calving-ease bull.
- ▶ He has performed with curve-bending results from 65 lbs. at birth to 645 lbs. at weaning to sire a calf crop that will weigh-up and pay-up while providing easy production.
- ▶ He has exceptional carcass results that is high in marbling and REA.
- ▶ He stems from a grand dam that posts a progeny WR 4@104 and YR 4@103.

20 VPI DOUBLE VISION 6D36

Calved: 10/14/2016 Bull +18793409 Tattoo: 6D36

Connealy Reflection # Bon View New Design 878
 Jindra Double Vision Happy Grill of Conanga 6260
 16748826 + Hoff Rachel 8312 405 # Hoff Limited Edition S C 594
 Hoff Miss Expo S C 4223
 # A A R Ten X 7008 S A # Mytty In Focus [RDF]
 VPI Miss Ambush 3A1 # A A R Lady Kelton 5551
 17536837 + VPI Miss Ambush 1Y3 #+ B/R Ambush 28
 G A R Objective 936

\$W	+48.85
\$F	\$F
MARB	+81
RE	\$G
FAT	.60
\$B	+45.57
\$B	-0.01
\$B	+137.05

CED	BW	WW	YW	Milk
+3	.33	+2.6	.46	+60
		.42	+109	.37
				+25
				.30

BW	AWW	RATIO	AYW	RATIO	IMF	REA	FAT	SCROTAL
85	847	ET	N/A	N/A	3.0	12.2	0.16	37.0

- ▶ **Power Bull**
- ▶ One of the heaviest bulls at weaning with a WW of 847 lb.
- ▶ This lean and athletic bull will not "melt-down" during the breeding season.
- ▶ His EPD profile ranks in the upper tier of non-parent bulls with balance and genetic profitability.
- ▶ Use him on cows for heavy weaning weights and to add growth and profitability.



Jindra Double Vision - Sire of Lot 20

21 VPI FORTRESS 6D28

Calved: 09/04/2016 Bull 18558018 Tattoo: 6D28

Connealy Consensus # KMK Alliance 6595 187
 K C F Bennett Fortress Blinda of Conanga 004
 +17259012 Thomas Patricia 9705 # S S Objective T510 0T26
 + Thomas Patricia 71138
 # G A R Predestined # B/R New Design 036
 VPI Rita 317 7T39 ET #+ G A R Ext 4206
 +16021999 + HHF Alli Rita 704 317 # Sitz Alliance 6595
 + G A R Ext 704

\$W	+90.36
\$F	\$F
MARB	+71
RE	\$G
FAT	+61
\$B	+38.28
\$B	+0.18
\$B	+149.81

CED	BW	WW	YW	Milk
+10	.34	+5	.51	+78
		.45	+142	.38
				+35
				.28

BW	AWW	RATIO	AYW	RATIO	IMF	REA	FAT	SCROTAL
83	636	89	1194	99	2.7	12.8	0.16	32.0

- ▶ Pounds-heavy bull that hails from the "Rita" cow family. His Grand Dam is the \$10,000 valued long-time VT Donor, "Rita 317".
- ▶ He ranks among the elite 1% of non-parent bulls on WWEPD, YWEPD, and \$W and 2% on \$F.
- ▶ His dam has been a long-time productive cow with 8 weaned with an average 96 ratio and 7 progeny recording a 103 YR.
- ▶ This athletic bull scored high on REA.



VPI Fortress 6D28 - Lot 21

22 VPI/DR HOMETOWN D606 ET

Calved: 09/01/2016		Bull P43811213		Tattoo: D606		BMI\$		
SHF WONDER M326 W18 ET (CHB,DLF,HYF,IEF)		KCF BENNETT 3008 M326 (CHB,SOD,DLF,HYF,IEF)		MARB		+\$ 23		
NJW 735 W18 HOMETOWN 10Y ET (CHB,DLF,HYF,IEF)		SHF GOVERNESS 236G L37 (DLF,HYF,IEF)		+0.11		CEZ\$		
P43214853		NJW P606 72N DAYDREAM 735 (DLF,HYF,IEF)		RE		+\$ 18		
DR WORLD CLASS 517 10H (SOD,DLF,HYF,IEF)		FELTONS 517 (SOD,HYF)		+0.67		BIIS		
DR LADY OF CLASS 10H WR01 ET (DLF,HYF,IEF)		VPI MARATHON LADY 0081		FAT		+\$ 17		
P43099204		DR STYLE & SUBSTANCE L02		+0.002		CHB\$		
		EF 821C MR CARCASS G824 (CHB)				+\$ 33		
		FOF 3N SASSY GAL B33						
		CED	BW	WW	YW	Milk		
		+3.1 P	+3.3 .23	+63 .22	+101 .22	+35 .19		
BW	AWW	RATIO	AYW	RATIO	IMF	REA	FAT	SCROTAL
85	441	ET	1134	ET	2.2	11.5	0.09	35.0

- ▶ He is a product of the ET program at VT.
- ▶ His Donor dam has been an exceptional producer with a progeny WR 2@106 and YR 2@110. His maternal grand dam records a progeny WR 7@110 and YR 5@102.
- ▶ He ranks among the elite 3% on M&G and top 10% on both WWEPD and CHB. He blends those values with a 15% ranking on YWEPD and REA.
- ▶ Maternal brother sells as Lot 23 and full brother sells as Lot 24.



VPI/DR HOMETOWN D606 ET - Lot 22

23 VPI RED BULL D615

Calved: 10/11/2016		Bull P43810632		Tattoo: D615		BMI\$		
CHURCHILL SENSATION 028X (CHB,SOD,DLF,HYF,IEF)		UPS DOMINO 3027 (CHB,SOD,DLF,HYF,IEF)		MARB		+\$ 22		
CHURCHILL RED BULL 200Z (CHB,DLF,HYF,IEF)		CHURCHILL LADY 7202T ET (DLF,HYF,IEF)		-0.03		CEZ\$		
P4321860		CHURCHILL LADY 002X ET (DLF,HYF,IEF)		RE		+\$ 19		
DR WORLD CLASS 517 10H (SOD,DLF,HYF,IEF)		FELTONS 517 (SOD,HYF)		+0.61		BIIS		
DR LADY OF CLASS 10H WR01 ET (DLF,HYF,IEF)		VPI MARATHON LADY 0081		FAT		+\$ 17		
P43099204		DR STYLE & SUBSTANCE L02		-0.015		CHB\$		
		EF 821C MR CARCASS G824 (CHB)				+\$ 30		
		FOF 3N SASSY GAL B33						
		CED	BW	WW	YW	Milk		
		+3.3 .19	+3.3 .36	+63 .29	+99 P+	+33 .15		
BW	AWW	RATIO	AYW	RATIO	IMF	REA	FAT	SCROTAL
90	533	99	956	95	1.7	10.6	0.15	36.0

- ▶ Maternal brother to Lots 22 and 24.
- ▶ This bull stacks a royal pedigree that blends many of the elite genetics in the Hereford breed.
- ▶ His dam is an exceptional producer with a progeny WR 2@106 and YR 2@110. His maternal grand dam has posted a progeny WR 7@110 and YR 5@102.
- ▶ He ranks in the elite 4% on M&G and top 10% on both WWEPD and CHB. He blends those top-of-the-breed values with a 15% ranking on YWEPD and REA.



Churchill Red Bull 200Z - Sire of Lot 23

24 VPI/DR BIG CITY D608 ET

Calved: 09/03/2016		Bull P43811217		Tattoo: D608		BMI\$		
SHF WONDER M326 W18 ET (CHB,DLF,HYF,IEF)		KCF BENNETT 3008 M326 (CHB,SOD,DLF,HYF,IEF)		MARB		+\$ 22		
NJW 735 W18 HOMETOWN 10Y ET (CHB,DLF,HYF,IEF)		SHF GOVERNESS 236G L37 (DLF,HYF,IEF)		+0.10		CEZ\$		
P43214853		NJW P606 72N DAYDREAM 735 (DLF,HYF,IEF)		RE		+\$ 18		
DR WORLD CLASS 517 10H (SOD,DLF,HYF,IEF)		FELTONS 517 (SOD,HYF)		+0.61		BIIS		
DR LADY OF CLASS 10H WR01 ET (DLF,HYF,IEF)		VPI MARATHON LADY 0081		FAT		+\$ 16		
P43099204		DR STYLE & SUBSTANCE L02		+0.022		CHB\$		
		EF 821C MR CARCASS G824 (CHB)				+\$ 31		
		FOF 3N SASSY GAL B33						
		CED	BW	WW	YW	Milk		
		+3.1 P	+3.3 .23	+63 .22	+101 .22	+35 .19		
BW	AWW	RATIO	AYW	RATIO	IMF	REA	FAT	SCROTAL
69	652	ET	1070	ET	1.8	11.3	0.18	38.0

- ▶ A product of the ET program and maternal brother to Lot 23. Full brother sells as Lot 22.
- ▶ This low-birth weight bull smashed the scales at weaning at over 650 lbs.
- ▶ His Donor dam records a progeny WR 2@106 and YR 2@110, while his maternal grand dam posts a progeny WR 7@110 and YR 5@102.
- ▶ He ranks among the elite 4% on M&G, upper 10% on WWEPD and CHB, and top 15% on YWEPD and REA.



VPI/DR Big City D608 - Lot 24

25 VPI RED BULL D614

Calved: 10/01/2016		Bull P43810774		Tattoo: D614		BMI\$		
CHURCHILL SENSATION 028X (CHB,SOD,DLF,HYF,IEF)		UPS DOMINO 3027 (CHB,SOD,DLF,HYF,IEF)		MARB		+\$ 22		
CHURCHILL RED BULL 200Z (CHB,DLF,HYF,IEF)		CHURCHILL LADY 7202T ET (DLF,HYF,IEF)		+0.03		CEZ\$		
P4321860		CHURCHILL LADY 002X ET (DLF,HYF,IEF)		RE		+\$ 19		
DR WORLD CLASS 517 10H (SOD,DLF,HYF,IEF)		FELTONS 517 (SOD,HYF)		+0.48		BIIS		
DR CLASSY LADY 10H B04		VPI MARATHON LADY 0081		FAT		+\$ 16		
P43458044		DR CLEOPATRA 9N U08		+0.009		CHB\$		
		LJR 73C NILES 9N (SOD)				+\$ 30		
		DR WPH LIL BOOMETTE 29F N20 (DOD)						
		CED	BW	WW	YW	Milk		
		+3.8 .18	+3.8 .35	+62 .29	+99 P+	+31 .14		
BW	AWW	RATIO	AYW	RATIO	IMF	REA	FAT	SCROTAL
88	550	102	981	98	1.8	11.8	0.21	34.0

- ▶ He stems from one of the all-time greats, "DR World Class 517 10H".
- ▶ He is a pounds-heavy bull that will add growth and profitability to your next calf crop.
- ▶ His EPD profile ranks him well above average on multiple traits. He is in the upper 10% on M&G and top 15% on WWEPD, YWEPD, CEZ, and CHB.



26 VPI HOMETOWN D613

Calved: 09/26/2016		Bull P43811222		Tattoo: D613		BMI\$		
SHE WONDER M326 W18 ET (CHB,DLF,HYF,IEF)		KCF BENNETT 3008 M326 (CHB,SOD,DLF,HYF,IEF)		MARB		+\$ 27		
NJW 735 W18 HOMETOWN 10Y ET (CHB,DLF,HYF,IEF)		SHE GOVERNESS 236G L37 (DLF,HYF,IEF)		CEZ\$		+\$ 21		
P43214853		PW VICTOR BOOMER P606 (SOD,DLF,HYF,IEF)		RE		+\$ 23		
KCF BENNETT 3008 M326 (CHB,SOD,DLF,HYF,IEF)		RRH MR FELT 3008 (CHB,SOD,DLF,HYF,IEF)		FAT		+\$ 32		
VPI VICTRA W911		KCF MISS 459 F284		FAT		+\$ 32		
P43066797		THM 5048 VICTRA 3222		FAT		+\$ 32		
BTF CONNECTION 540 5048		THM PM DOMINETTE 1210		CED		BW		
				WW		YW		
				Milk				
				+4.7		.19		
				+0.3		.38		
				+48		.30		
				+83		P+		
				+27		.20		
BW	AWW	RATIO	AYW	RATIO	IMF	REA	FAT	SCROTAL
65	503	92	974	100	3.4	11.7	0.18	36.0

► Heifer Bull

- This bull will be ideal to breed to heifers without sacrificing pounds on your next calf crop.
- He is another son of the very popular "Hometown" sire and the "Victra" cow family.
- He ranks among the upper 5% on CEZ and top 15% on BII and BMI.
- His dam has been one of the good ones with a progeny WR 5@95.



NJW 735 W18 Hometown 10 Y ET - Sire of Lots 4A, 12A, 22, 24, and 26

27 VPI RED BULL D616

Calved: 10/14/2016		Bull P43810779		Tattoo: D616		BMI\$		
CHURCHILL SENSATION 028X (CHB,SOD,DLF,HYF,IEF)		UPS DOMINO 3027 (CHB,SOD,DLF,HYF,IEF)		MARB		+\$ 22		
CHURCHILL RED BULL 200Z (CHB,DLF,HYF,IEF)		CHURCHILL LADY 7202T ET (DLF,HYF,IEF)		CEZ\$		+\$ 19		
P43281860		GOLDEN OAK OUTCROSS 18U (SOD,CHB,DLF,HYF,IEF)		RE		+\$ 16		
CHURCHILL LADY 002X ET (DLF,HYF,IEF)		CHURCHILL LADY 600S ET (DLF,HYF,IEF)		FAT		+\$ 33		
MSU TCF REVOLUTION 4R (SOD,CHB,DLF,HYF,IEF)		FELTONS LEGEND 242 (SOD,HYF)		FAT		+\$ 33		
VPI RACHELS BLAZE Z207		MSU TCF RACHAEL ET 54N (DLF,HYF,IEF)		FAT		+\$ 33		
P43324704		DR RACHEL'S BLAZE 29F T20 ET (SOD,DLF,HYF,IEF)		FAT		+\$ 33		
		WJG LADY BLAZE 173		CED		BW		
				WW		YW		
				Milk				
				+4.3		.19		
				+2.7		.37		
				+61		.30		
				+106		P+		
				+29		.15		
BW	AWW	RATIO	AYW	RATIO	IMF	REA	FAT	SCROTAL
85	581	107	1054	106	1.6	11.0	0.18	36.0

► Power Bull

- He smashed the scales with a 107 WR and 106 YR.
- He ranks among the top 10% on M&G, REA, and CHB. He stands with the 15% tier on WVEPD, YVEPD, BMI, and CEZ.
- He will add pounds and breed rank to make your next calf crop more valuable.

28 VPI DURANGO SPIRIT D604

Calved: 08/22/2016		Bull P43810629		Tattoo: D604		BMI\$		
THM DURANGO 4037 (CHB,SOD,DLF,HYF,IEF)		CS BOOMER 29F (SOD,DLF,HYF,IEF)		MARB		+\$ 20		
NJW 765 4037 DURANGO SPIRIT 174X (DLF,HYF,IEF)		THM 7085 VICTRA 9036 (DLF,HYF,IEF)		CEZ\$		+\$ 22		
P43092746		NJW 55N STARDUST 76S (DLF,HYF,IEF)		RE		+\$ 15		
NJW 57G SPIRIT QUEEN 55N ET (DLF,HYF,IEF)		CHURCHILL SENSATION 028X (CHB,SOD,DLF,HYF,IEF)		FAT		+\$ 24		
CHURCHILL RED BULL 200Z (CHB,DLF,HYF,IEF)		CHURCHILL LADY 002X ET (DLF,HYF,IEF)		FAT		+\$ 24		
VPI STYLISH LADY B413		KCF BENNETT 774 R413 (SOD,DLF,HYF,IEF)		FAT		+\$ 24		
P43552712		VPI STYLISH LADY Y104		FAT		+\$ 24		
				CED		BW		
				WW		YW		
				Milk				
				+7.7		.14		
				-1.9		.36		
				+50		.28		
				+81		P+		
				+27		.11		
BW	AWW	RATIO	AYW	RATIO	IMF	REA	FAT	SCROTAL
59	582	108	1021	107	2.5	10.7	0.25	32.0

► Heifer Bull

- He exhibits curve-bending performance with a 59 lb. BW and a WW and YW ratio of 108 and 102, respectively.
- He ranks among the elite 4% on CEZ.
- Use this bull on heifers without sacrificing those heavy calves at weaning. Ideal bull to use in an F1 program to make those highly marketable "baldy" calves.

Hokie Simmental Service Age Bulls



EBS Shesa Andreas Dream - Donor Dam of Lots 29, 30, 31, 32

EBS Shesa Andreas Dream DOB: 1/3/05 Reg#: 2275886

Featuring 4 Flush brothers, Lots 29-32, of this long-time productive VT Donor cow.

- She is phenotypically flawless with udder quality, base width, depth, and volume without sacrificing femininity. She is sound and walks out with animation on a big foot.
- She has been a highly productive cow with a WR 7@105 on natural progeny and a reported 51 ET calves.
- Any son of this cow will vault your purebred or commercial herd to the next level.

29 VPI BROADWAY D691 ET

Calved: 10/15/2016		Bull 3253617		Tattoo: D691	
MCM TOP GRADE 018X	MR NLC UPGRADE U8676			MARB	
HOOK'S BROADWAY 11B	MCM 513R			0.46	
2854437 HOOK'S WATER LILY 89W	HOOKS TAURUS 24T			RE	
	HOOKS GRACIE 68K			API	
	NICHOLS LEGACY G151			1.15	
CNS DREAM ON L186	CNS SHEEZA DREAM K107W			FAT	
EBS SHESA ANDRIAS DREAM	HC POWER DRIVE 88H			TI	
2275886 TRIPLEC SHESAVANNAH K137	G&L SAVANNAH 607C			-0.046	
				77.8	

CED	BW	WW	YW	Milk
7.7	0.24	1.1	0.25	61.9
0.25	89.8	0.25	27.0	0.19

BW	AWW	RATIO	AYW	RATIO	IMF	REA	FAT	SCROTAL
86	725	ET	1140	ET	1.9	12.9	0.09	33.0

► **Purebred Simmental**

► **Homozygous Black and Homozygous Polled**

- The first of 4 flush brothers by Hook's Broadway 11B.
- This athletic performance bull weaned at over 700 lbs..
- He will add carcass quality as he ranks in the elite 4% on REA and 5% on Marbling. He blends carcass value with a top 10% ranking on YG and 15% on Milk, Shr, API, and TI.



VPI Broadway D691 ET - Lot 29

30 VPI BROADWAY D688 ET

Calved: 09/07/2016		Bull 3159874		Tattoo: D688	
MCM TOP GRADE 018X	MR NLC UPGRADE U8676			MARB	
HOOK'S BROADWAY 11B	MCM 513R			0.41	
2854437 HOOK'S WATER LILY 89W	HOOKS TAURUS 24T			RE	
	HOOKS GRACIE 68K			API	
	NICHOLS LEGACY G151			1.10	
CNS DREAM ON L186	CNS SHEEZA DREAM K107W			FAT	
EBS SHESA ANDRIAS DREAM	HC POWER DRIVE 88H			TI	
2275886 TRIPLEC SHESAVANNAH K137	G&L SAVANNAH 607C			-0.054	
				76.8	

CED	BW	WW	YW	Milk
7.7	0.24	1.1	0.25	61.9
0.25	89.8	0.25	27.0	0.19

BW	AWW	RATIO	AYW	RATIO	IMF	REA	FAT	SCROTAL
77	722	ET	1170	ET	1.8	13.8	0.13	35.0

► **Purebred Simmental**

► **Homozygous Black and Homozygous Polled**

- Flush brother to Lots 29, 31, and 32.
- Low birth weight with pounds and performance at weaning and yearling.
- He will add carcass with a big REA and smashed the scales at over 700 lbs. at weaning.
- He ranks in the elite 4% on REA and 5% on Marbling. He blends carcass value with a top 10% ranking on YG and 15% on Milk, Shr, API, and TI.



VPI Broadway D688 ET - Lot 30

31 VPI BROADWAY D690 ET

Calved: 10/13/2016		Bull 3253616		Tattoo: D690	
MCM TOP GRADE 018X	MR NLC UPGRADE U8676			MARB	
HOOK'S BROADWAY 11B	MCM 513R			0.39	
2854437 HOOK'S WATER LILY 89W	HOOKS TAURUS 24T			RE	
	HOOKS GRACIE 68K			API	
	NICHOLS LEGACY G151			1.14	
CNS DREAM ON L186	CNS SHEEZA DREAM K107W			FAT	
EBS SHESA ANDRIAS DREAM	HC POWER DRIVE 88H			TI	
2275886 TRIPLEC SHESAVANNAH K137	G&L SAVANNAH 607C			-0.059	
				76.4	

CED	BW	WW	YW	Milk
7.7	0.24	1.1	0.25	61.9
0.25	89.8	0.25	27.0	0.19

BW	AWW	RATIO	AYW	RATIO	IMF	REA	FAT	SCROTAL
85	651	ET	1027	ET	1.6	12.8	0.05	32.0

► **Purebred Simmental**

► **Homozygous Black and Homozygous Polled**

- A product of the VT ET program and flush brother to Lots 29, 30, and 32.
- He is another big REA bull with loads of pounds to offer your next calf crop.
- He ranks in the elite 4% on REA and 5% on Marbling. He blends carcass value with a top 10% ranking on YG and 15% on Milk, Shr, API, and TI.

32 VPI BROADWAY D687 ET

Calved: 09/06/2016		Bull 3159873		Tattoo: D687	
MCM TOP GRADE 018X	MR NLC UPGRADE U8676			MARB	
HOOK'S BROADWAY 11B	MCM 513R			0.44	
2854437 HOOK'S WATER LILY 89W	HOOKS TAURUS 24T			RE	
	HOOKS GRACIE 68K			API	
	NICHOLS LEGACY G151			1.19	
CNS DREAM ON L186	CNS SHEEZA DREAM K107W			FAT	
EBS SHESA ANDRIAS DREAM	HC POWER DRIVE 88H			TI	
2275886 TRIPLEC SHESAVANNAH K137	G&L SAVANNAH 607C			-0.051	
				77.4	

CED	BW	WW	YW	Milk
7.7	0.24	1.1	0.25	61.9
0.25	89.8	0.25	27.0	0.19

BW	AWW	RATIO	AYW	RATIO	IMF	REA	FAT	SCROTAL
86	699	ET	1130	ET	1.9	14.7	0.14	37.0

► **Purebred Simmental**

► **Homozygous Black and Homozygous Polled**

- Athletic, moderate framed with muscle and phenotype.
- Flush brother to Lots 29-31 that blends Hook's Broadway 11B with the impeccable "Andrias Dream" Donor.
- Like his brothers, his performance and carcass traits will yield progeny that are profitable in all phases of your program.
- He ranks in the elite 4% on REA and 5% on Marbling. He blends carcass value with a top 10% ranking on YG and 15% on Milk, Shr, API, and TI.



Hook's Broadway 11B - Sire of Lots 29-32



Hokie Commercial Bred Heifers



33 VPI 6005
 Calved: 1/7/16 Breed: ANGUS Tattoo: 6005
 Sire: Connealy Final Four 0411 MGS: KCF Bennett Total
 ▶ Due 2/5/18 to EF Commando

38 VPI 6040
 Calved: 2/2/16 Breed: ANGUS Tattoo: 6040
 Sire: EF Component MGS: OCC Great Plains
 ▶ Due 3/11/18 to MSA Diesel Power SC15

34 VPI 6006
 Calved: 1/8/16 Breed: ANGUS Tattoo: 6006
 Sire: Connealy Final Four 0411 MGS: Sinclair Net Present Value
 ▶ Due 3/11/18 to MSA Diesel Power SC15

39 VPI 6083
 Calved: 2/10/16 Breed: ANGUS Tattoo: 6083
 Sire: Connealy Honest Answer MGS: Nichols Legacy
 ▶ Due 3/18/18 to MSA Diesel Power 5C15

35 VPI 6021
 Calved: 1/26/16 Breed: ANGUS Tattoo: 6021
 Sire: EF Component MGS: Angus
 ▶ Due 2/5/18 to Barstow Bankroll B73

40 VPI 6086
 Calved: 2/12/16 Breed: ANGUS Tattoo: 6086
 Sire: Connealy Imprint MGS: Angus
 ▶ Due 2/5/18 to Barstow Bankroll B73

36 VPI 6023
 Calved: 1/29/16 Breed: ANGUS Tattoo: 6023
 Sire: Connealy Trustmark MGS: Angus
 ▶ Due 2/10/18 to EF Commando

41 VPI 6087
 Calved: 2/14/16 Breed: ANGUS Tattoo: 6087
 Sire: Connealy Final Four 0411 MGS: GAR Predestined
 ▶ Due 2/4/18 to Barstow Bankroll B73

37 VPI 6026
 Calved: 1/29/17 Breed: ANGUS Tattoo: 6026
 Sire: EF Component MGS: Angus
 ▶ Due 2/3/18 to EF Commando

42 VPI 6092
 Calved: 2/26/16 Breed: ANGUS Tattoo: 6092
 Sire: Connealy Honest Answer MGS: Angus
 ▶ Due 3/18/18 to MSA Diesel Power 5C15

Hokie Commercial Bred Cows

43 VPI 2065
 Calved: 2/14/12 Breed: Angus Tattoo: 2065
 Sire: OCC Great Plains MGS: Angus
 ▶ Due 4/17/18 to VPI Lock Down D665 (3/4 Sim X 1/4 Angus)

47 VPI 5052
 Calved: 2/1/15 Breed: SimAngus Tattoo: 5052
 Sire: Boyd New Day 44 MGS: TNT Jump Start
 ▶ Due 4/17/18 to VPI Lock Down D665 (3/4 Sim X 1/4 Angus)

44 VPI 2072
 Calved: 2/15/12 Breed: Angus Tattoo: 2072
 Sire: Connealy Power One MGS: Angus
 ▶ Due 4/17/18 to VPI Lock Down D665 (3/4 Sim X 1/4 Angus)

48 VPI 8028
 Calved: 3/15/08 Breed: Angus Tattoo: 8028
 Sire: Angus MGS: Angus
 ▶ Due 4/17/18 to VPI Lock Down D665 (3/4 Sim X 1/4 Angus)

45 VPI 3015
 Calved: 1/10/13 Breed: Angus Tattoo: 3015
 Sire: OCC Emblazon MGS: Angus
 ▶ Due 4/17/18 to VPI Lock Down D665 (3/4 Sim X 1/4 Angus)

49 VPI 8064
 Calved: 3/25/08 Breed: Angus Tattoo: 8064
 Sire: Angus MGS: Angus
 ▶ Due 4/17/18 to VPI Lock Down D665 (3/4 Sim X 1/4 Angus)

46 VPI 3035
 Calved: 2/5/13 Breed: Angus Tattoo: 3035
 Sire: Sinclair Net Present Value MGS: Angus
 ▶ Due 4/17/18 to VPI Lock Down D665 (3/4 Sim X 1/4 Angus)

50 VPI 0003
 Calved: 1/20/10 Breed: Angus Tattoo: 3
 Sire: Angus MGS: Angus
 ▶ Due 4/17/18 to VPI Lock Down D665 (3/4 Sim X 1/4 Angus)



A S WHITLOCK 179

Calved: 03/21/2011		Bull 17007891		Tattoo: 179		\$W			
S Alliance 3313		+ Paws Up Alliance 9561		MARB		+76.95			
S Chisum 6175		Paws Up 9048 Emulation Ext		+ .28		+ \$F			
#15511451 # S Gloria 464		S Eclipse 169		RE		+86.22			
# R&S Expedition 1404 (RDF)		# S Gloria 209		+ .61		+ \$G			
S Pride Anna 709		Basin Expedition 6241		FAT		+16.57			
#15897036 # S Pride Anna 567		+ R&S Clova Pride E51		+ .031		+ \$B			
		#+ G A R Grid Maker							
		Pride Anna 2244							
CED	BW	WW	YW	Milk					
+12	.61	+1.0	.85	+73	.81	+131	.73	+29	.49



S Whitlock 179 - Reference Sire A

B HA Cowboy Up 5405

Calved: 01/30/2015		Bull 18286467		Tattoo: 5405		\$W			
KG Solution 0018		# MOGCK Sure Shot		MARB		+59.73			
HA Outside 3008		KG Rito Lady 8724		- .05		+ \$F			
17651088 # HA Ever Lady 1575		#+ S A V Bismarck 5682 (RDF)		RE		+137.25			
HA Program 7328		HA Ever Lady 8066		+ .65		+ \$G			
HA Blackcap Lady 1602		# HA Program 5652		FAT		+5.14			
#17055741 HA Blackcap Lady 5515		+ H A Forever Lady 0210		- .018		+ \$B			
		# E&b 4137 Dominett 814							
		+ HA Blackcap Lady 3833							
CED	BW	WW	YW	Milk					
+8	.38	+2.3	.76	+81	.37	+146	.44	+11	.28



HA Cowboy Up 5405 - Reference Sire B

C KT SMALL TOWN KID 5051 (DLF,HYF,IEF)

Calved: 02/18/2015		Bull P43621413		Tattoo: 5051		BMI\$			
SHF WONDER M326 W18 ET (CHB,DLF,HYF,IEF)		KCF BENNETT 3008 M326 (CHB,SOD,DLF,HYF,IEF)		MARB		+\$ 24			
NJW 73S W18 HOMETOWN 10Y ET (CHB,DLF,HYF,IEF)		SHF GOVERNESS 236G L37 (DLF,HYF,IEF)		+0.33		+\$ 20			
P43214853 NJW P606 72N DAYDREAM 73S (DLF,HYF,IEF)		PW VICTOR BOOMER P606 (SOD,DLF,HYF,IEF)		RE		BIIS			
RST TIMES A WASTIN 0124 (CHB,DLF,HYF,IEF)		NJW 94J DEW 72N (DLF,HYF,IEF)		+0.54		+\$ 19			
KT MS 0124 TIMES A WASTIN 2086 (DOD,DLF,HYF,IEF)		CRR ABOUT TIME 743 (CHB,SOD,DLF,HYF,IEF)		FAT		CHB\$			
43290330 KT MS K085 PROSPECTOR 4016 (DOD)		RST MS 1000 BLAZER 2029 (DOD,DLF,HYF,IEF)		+0.000		+\$ 35			
		HUTH PROSPECTOR K085 (SOD,CHB,DLF,HYF,IEF)							
		KT MS 2D ENHANCER 2058 (DOD)							
CED	BW	WW	YW	Milk					
+5.7	.34	+0.5	.54	+56	.38	+91	.39	+38	.22



KT Small Town Kid 5051 - Reference Sire C

D HOOK'S YELLOWSTONE 97Y

Calved: 03/08/2011		Bull 2612546		Tattoo: 97Y		MARB			
HOOKS SHEAR FORCE 38K		NICHOLS LEGACY G151		0.31		API			
HOOKS TAURUS 24T		C&D TRACY		RE		161.9			
2389824 HOOKS PEACHES 48-P		BON VIEW NEW DESIGN 878		0.77		TI			
SRS J914 PREFERRED BEEF		ESJ4		FAT		80.7			
HOOKS SHEYENNE 77S		LRS PREFERRED STOCK 370C		-0.040					
2334151 TRIPLE C TEARS P02C		SRS G733 GLIMMER							
		HC POWER DRIVE 88H							
		HS TEAR DROP J27							
CED	BW	WW	YW	Milk					
16.1	0.86	-0.6	0.92	+9.5	0.90	101.5	0.89	21.4	0.79



Hook's Yellowstone 97Y - Reference Sire D

E SPRING COVE PAYGRADE 5064

Calved: 01/30/2015		Bull 18251392		Tattoo: 5064		SW	
#+ Basin Payweight 0065		# Vermilion Payweight J847		MARB		+66.78	
Basin Payweight 1682		+ Basin Lucy 3829		+1.04		+52.83	
+17038724 21AR O Lass 7017		# ARB Pendleton 765 JH		RE		\$G	
C C A Emblazon 702		21AR O Lass F24A		+.23		+39.60	
Spring Cove Ella 064		#+ O C C Emblazon 854E		FAT		\$B	
16773411 Spring Cove Ella 747		Limestone Blackcap R128		+.054		+127.24	
		+ Spring Cove OnTime SB 100B		CED		BW	
		Spring Cove Ella 341		+12 .35		-4 .55	
				WW		+57 .48	
				YW		+95 .42	
				Milk		+26 .30	



Springgrove Paygrade 5064 - Reference Sire E

F DEER VALLEY OLD HICKORY

Calved: 01/16/2014		Bull 17873666		Tattoo: 4181		SW	
# Sitz Upward 307R		# Connealy Onward		MARB		+74.76	
Plattemere Weigh Up K360		Sitz Henrietta Pride 81M		+.58		+83.70	
16692552 # Barbara of Plattemere 337		G A R Retail Product		RE		\$G	
#+ S A V Bismarck 5682 [RDF]		Barbara of Plattemere 311		+.50		+37.34	
Deer Valley Rita 1126		#+ G A R Grid Maker		FAT		\$B	
+16964741 G A R Objective 2345		S A V Abigale 0451		-.009		+149.69	
		# S S Objective T510 OT26		CED		BW	
		+ G A R 1407 New Design 2413		+13 .49		+6 .73	
				WW		+64 .68	
				YW		+113 .45	
				Milk		+29 .34	



Deer Valley Old Hickory - Reference Sire F

G BARSTOW BANKROLL B73

Calved: 02/14/2014		Bull 18036327		Tattoo: B73		SW	
# Sitz Dash 10277		# Sitz Upward 307R		MARB		+59.02	
Barstow Cash		+ Sitz Everelda Entense 2665		+.45		+94.85	
17145326 Barstow Queen W16		# S A V Final Answer 0035 [RDF]		RE		\$G	
# CAR Efficient 534		RCA Queen R42		+.63		+33.38	
Barstow Miss Dianna Z25		C F Bennett Efficient		FAT		\$B	
17479418 # Barstow Miss Dianna X128		# CAR Miss Susie 308		-.018		+147.46	
		# SydGen C C & 7		CED		BW	
		Barstow Miss Dianna BA T134		+15 .55		-2.7 .80	
				WW		+62 .75	
				YW		+128 .52	
				Milk		+23 .34	



Barstow Bankroll B73 - G

H MSA DIESEL POWER 5C15

Calved: 10/17/2015		Bull 18321799		Tattoo: 5C15		SW	
#+ PA Power Tool 9108		# G A R Predestined		MARB		+55.41	
PA Full Power 1208		Shamrocks Beebee Queen 3095		+.74		+51.27	
+16981588 Pine View SQR Rita W091		#+ G A R New Design 5050		RE		\$G	
# MCC Daybreak		+ Pine View Rita R084		+.77		+45.64	
MSA Shawnee 0X8		#+ Boyd New Day 8005		FAT		\$B	
16819225 MSA Shawnee 8U15		# MCC Miss Focus 134		+.018		+116.91	
		# TC Total 410		CED		BW	
		+ MSA Shawnee 5R9 ET		+10 .24		-1.2 .35	
				WW		+58 .31	
				YW		+97 .28	
				Milk		+20 .19	



PA Full Power 1208 - H

VPI LOCK DOWN D665 ET

Calved: 02/04/2016 Bull 3123969 Tattoo: D665
 REMINGTON LOCK N LOAD54U REMINGTON ON TARGET 2S
W/C LOCK DOWN 206Z BAR15 MISS KNIGHT78E-51G
 2658496 G C F MISS NEW LEVELR206 IRONWOOD NEW LEVEL
 M A F EILEEN 0113
 CNS DREAM ON L186 NICHOLS LEGACY G151
EBS SHESA ANDRIAS DREAM CNS SHEEZA DREAM K107W
 2275886 TRIPLEC SHESAVANNAH K137 HC POWER DRIVE 88H
 G&L SAVANNAH 607C

MARB	0.32
RE	0.77
FAT	-0.043
API	148.3
TI	72.3

CED	BW	WW	YW	Milk
16.9 0.31	-0.9 0.38	62.7 0.33	94.3 0.35	16.9 0.27



WC Lockdown 206Z - Reference Sire I

Virginia Tech University Beef Center earns 2017 AICA Outstanding Seedstock Producer Award

KANSAS CITY, Mo. — At the Annual Membership Meeting of the American-International Charolais Association (AICA) held in Corpus Christi, Texas, Monday, March 27, 2017, the Virginia Tech University Beef Center received the 2017 Outstanding Seedstock Producer Award. Dr. Dan Eversole, Director of Beef Programs, received the award on behalf of the University. The Virginia Tech Beef Center's Charolais herd consists of 40 purebred breeding-age females. Charolais were introduced to the Virginia Tech Beef Center in 1998 through donations and support of Charolais breeders across the country, led by Mrs. Mary diZerega, Oakdale Farm, Upperville, Virginia. Dr. Eversole teaches classes and involves students in the management and merchandising of the purebred cattle, and Director of Beef Operations, Chad Joines, manages the day-to-day activities and coordinates the cattle needs for teaching, extension and research faculty.

Virginia Tech follows a strict record keeping regiment. Birth weight, weaning weight, yearling weight and yearling height are measured and reported to AICA. All calves are weighed and recorded at birth and later registered. Ultrasound data is processed at 12 months of age and reported to AICA. Every bull sold private treaty or consigned to a sale is DNA-tested for polledness and EPD accuracy. One of Virginia Tech's purebred herdsires, VPI Free Lunch 708T, was purchased by Select Sires in 2008 as a yearling. Free Lunch has been successful in the commercial industry as well as the purebred, being named a Multiple Trait Leader in the AICA Sire Summary.

AICA Southeast Field Representative Floyd Wampler stated, "Virginia Tech has set a very high standard of leadership for registration, data collection, use of modern technology, marketing, customer satisfaction and educating college students in the beef industry using their Charolais herd as a teaching tool. We are fortunate to have them in their positions and as Charolais breeders and promoters."



Dr. Dan Eversole accepts this award on behalf of VA Tech from Mr. Bill Nottke, President of the American-International Charolais Association, at the March BOD meeting in Corpus Christi, TX.



September 8, 2017

Dear Friends and Supporters,

It is our honor and privilege as the 2017 Livestock Merchandising Class at Virginia Tech to present to you the 23rd Annual Hokie Harvest Sale Catalog. As we strive to uphold the high standards of quality and tradition set by previous classes, we request your presence Friday, October 27th at the 2017 Hokie Harvest Sale in Blacksburg, Virginia. The sale will begin at 6:30 p.m. in the Animal Judging Pavilion located at 500 Plantation Road.

Now in its 23rd year, this auction continues to be a joint effort of all the students in the Livestock Merchandising Class. Willing professionals have served as guest speakers and mentors during class time and have educated us on sale preparation and administration as we plan and oversee the sale. Organizing the Hokie Harvest Sale teaches our class valuable skills such as the management and coordination of a production sale, while providing high quality, hand-picked livestock to the public. This year's auction will include 61 commercial and purebred beef cattle along with a lot of three embryos. Our elite selection of cattle includes 4 purebred spring pair splits, 8 fall-calving purebred cows, 18 spring-calving commercial cows and heifers, and 19 breeding age bulls.

The Hokie Harvest Sale will also include an online auction of eight Quarter Horses and seven Warmbloods. A variety of weanlings, yearlings, and two-year-olds will be offered. The online auction of these impressive horses will open on October 1st and close at 6 p.m. on October 27th. All proceeds from the Hokie Harvest Sale directly benefit departmental programs.

We appreciate your invaluable support and invite you to attend a complimentary barbeque dinner served prior to sale time in the Alphin-Stuart Arena. Join the fellowship with us and enjoy some delicious food! Thank you for your past and continued interest in helping us further our education as we serve you. "Come Experience the Harvest" with us at the 23rd Annual Hokie Harvest Sale; we look forward to seeing you!



Sincerely,

Catalog and Social Media Committee:

Kylie Ferrentino, Sara Gordon, Alexa Johnson, Michael Leonard, Cassandra Long, Miranda Payne, and Sydney Varney

2017 Virginia Tech Livestock Merchandising Class

SALE DAY ACTIVITIES

- 2:00 – 6:00 pmDemonstration of Sale Horses - Campbell Arena
- 3:00 – 7:00 pm Buyer Registration
- 4:30 – 6:30 pm Complimentary Barbecue Dinner at the Alphin-Stuart Arena
- 6:30 pm Sale Time - Animal Judging Pavilion



HOKIE HARVEST ONLINE HORSE SALE

Bidding opens Sunday, October 1st, 2017
Bidding closes Friday, October 27th, 2017 at 6pm
Auction site: <https://horsesales.cals.vt.edu/>
Sale Day Phone: Lot #1-9 Lisa Nulton (585) 662-3102
Lot #10-15 Bridgett McIntosh (540) 687-3521 ext 22

Horse Sale Showcase

Friday, October 27th, 2017 from 2pm-6pm

During this event, all sale horses will be available to be viewed and handled by potential buyers.

Lot#1-9: Virginia Tech Campus in Campbell Arena

500 Plantation Rd, Blacksburg, VA 24061

AQHA Facebook: <https://www.facebook.com/SmithfieldHorseCenter>

Lot #10-15: MARE Center

5527 Sullivans Mill Rd, Middleburg, Virginia, VA 2011 5527

Warmblood Facebook: <https://www.facebook.com/MARECenter/>

Training Details

Lot #1-9 sold during the Hokie Harvest Online Sale have participated in the Behavior and Training course. During this course students' work with the Virginia Tech yearlings and weanlings teaching the horses to lead, tie, load, stall, stand for the farrier, bathing and clipping. The yearlings are all taught to stand to be tacked, accepting a saddle and bit, and lunge quietly. Lot#10-15 sold during the Hokie Harvest Online Sale have participated in the MARE Center Internship Program and Graduate Student Training Program teaching the horses to lead, load, stall, stand for the farrier and routine veterinary care, grooming, bathing and clipping. The two year olds have gone through the same training and handling with the addition of introduction to tack.

Terms and Conditions

Applicable Law: All horses are offered according to the laws of the State of Virginia. There are no warranties or guarantees implied as to the fitness for any particular purpose(s) of any horse offered in this sale. Our best efforts have been employed to document unsoundnesses or vices in any animal and such records are available for review before the sale. Bidders are cautioned to examine records and horses closely before bidding and purchasing. Every effort has been made to give complete disclosure of all known negative factors (health, disposition, management, etc.) on all horses in the sale. However, no employee or agent of Virginia Tech can or shall be considered responsible for any oversight of a fault. All horses are sold "caveat emptor" (buyer beware). All sales are final and absolute. No refunds will be given for any reason.

Pre-purchase exams: Prospective buyers are encouraged to carry out pre-purchase exams on sales horses of interest. Pre-purchase exams will be completed at the prospective bidder's expense, and may be completed by a licensed veterinarian of their choice. Pre-purchase exams must be scheduled in advance and with an employee or agent of Virginia Tech in attendance during the exam. Pre-purchase exams must be completed no later than Tuesday, October 24th. Procedures to be done during the exam must be approved in advance. No flexion tests will be permitted on horses two years old or younger without permission. Pre-purchase exams must be carried out at the Smithfield Horse Center or the MARE Center and horses must be handled at all times by employees or agents of Virginia Tech.

Bidding Procedure: Registration as a bidder commits that bidder to purchase any horse for which he/she has the winning (high) bid. The online bidding will close promptly at 6:00 pm on Friday, October 27th. No bid will be valid after 6:00pm on Friday, October 27th.

Assumption of Risk: The purchaser, at the close of bidding, assumes all risk and responsibility for the horse. All horses must be removed from the farm within 14 days of the end of the online bidding. During the stay of the horse, Virginia Tech shall continue to provide all normal care and neither Virginia Tech, nor its employees, officers, agents shall be liable for any accidents, disease, death or injury to any horse. Nor shall the aforementioned agents be responsible for any accidents or injuries inflicted by the horse on any persons, facilities or equipment. Sales horses are accustomed to traveling untied in a box stall in a fully-enclosed stock trailer. It is the buyer's responsibility to provide suitable transport for purchased horses and Virginia Tech, its employees, officers or agents will not be responsible for any accidents or injuries to animals, persons, or equipment during or after any horse is loaded onto a trailer. Students and/or staff will be available to assist with loading of horses, but without any liability being accepted for injury or accidents to animals, persons, or equipment.

Sales Conditions and Payment: All sales are final. Purchasers may not stop payment of a horse for any reason if he/she is the high bidder at the close of bidding. There will be a 5.3% service fee added to all final/winning bids.

Public Liability: Neither Virginia Tech, nor its employees, officers or agents assume any responsibility for any injury, death, or damage of any kind to a person or animal. The public is not allowed in any stall, paddock, or pastures without permissions. Examine horses at your own risk. The public is cautioned to be very careful while on the grounds examining horses and particularly while horses are being handled, ridden or driven.

LOT 1 VT ZIPPO TO Sixty

		Sure Tuffly Too
Sire: Amber Pass	Uncle Geoff	Skips Fancy Rose
	Maybelleni (T)	Amber Pass (T)
		LUSU (T)
Dam: CU Hot Sensation	Zippos Hot Wheels	Zippo Bud
		The Blue Coupe
	Daisy Dee Dana	Sonnys Sensation
		Dana Boyd



VT Zippo To Sixty, “Cliff”, is a talented 2016 bay gelding out of CU Hot Sensation whose lineage traces back to the infamous Zippo Pine Bar, NSBA and AQHA Hall of Famer and an all-time leading sire of High Point Performance Horses. His maternal sire, Sonny’s Sensation, has produced successful All Around offspring earning multiple ROMS. Cliff’s sire Amber Pass, a proven producer of quality hunter type progeny, is a ROM earner in Hunter Under Saddle, Hunter Hack, and Working Hunter. This yearling is sure to have a promising future in the show ring.

LOT 2 VT Pass The Invite

		Sure Tuffly Too
Sire: Amber Pass	Uncle Geoff	Skips Fancy Rose
	Maybelleni (T)	Amber Pass (T)
		LUSU (T)
Dam: Whose Envious	Green with Invy	Invitation Only
		Bold Vanessa
	Luke Whoo	Luke At Me
		Wahoo



VT Pass The Invite, “Denali”, is a beautiful 2016 brown filly by the ROM earner Amber Pass. Her dam, AQHA point earner, Whose Envious, is a granddaughter of the great Invitation Only. She is by Green With Invy, a 3 time European Performance Halter Stallion Champion, a Performance ROM earner, and a 3rd place World Show Performance Halter Stallion with 50% of his offspring performing. Denali is a granddaughter of Congress and World Champion Luke At Me. Denali is the first foal out of Whose Envious, and with her ground covering movement she will make a promising hunter prospect.

LOT 3 VT Boons Legacy

		Peptoboonsmal
Sire: Boons Hired Hand	Lenas Lil Boon	Lenas Joy
	Hired Hand Paloma	Pepps Paloto
		Esther
Dam: Don’t Sass Me Bert	Oakoboji Bert	Doc’s Oak
		Berts Spunky
	Pages Sassy Girl	Baron Star Jack
		Bert Sassy



VT Boons Legacy, “Logan”, is a handsome 2016 red roan gelding and the last progeny by Boons Hired Hand, a 2004 grandson of the great Peptoboonsmal, an All-Time Leading Sire. Logan is bred equally as notable on his dam’s side with her lines going back the great foundation sire, Doc’s Oak. Logan is short coupled with exceptional balance offering him a promising career in the Ranch Horse world.

LOT 4 VT Blackbear Whiskey

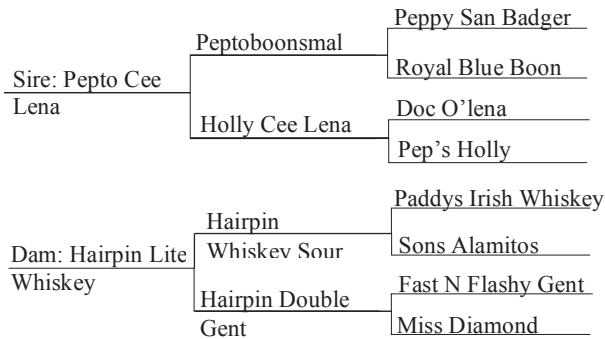

VT Blackbear Whiskey, "Bear", is an athletic 2016 roan gelding out of Hairpin Lite Whiskey, a granddaughter of the AQHA World/ Res. World Champion Sire and a NRCHA All-Time Leading Sire, Paddys Irish Whiskey. Bear is by Pepto Cee Lena, a young promising stallion with an outstanding show recording. This yearling has tremendous suspension and flat floating stride, giving Bear the potential to excel in any show arena.

LOT 5 VT Boon Bourbon Babe

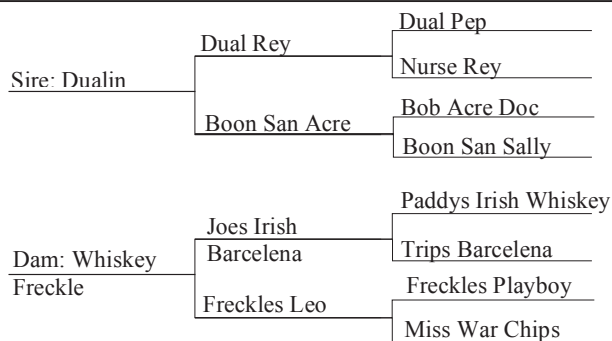

VT Boon Bourbon Babe, "Aspen", is an intelligent 2016 sorrel filly by Dualin Boon, son of Dual Rey whose offspring have earned more than \$26 million. Dualin Boon is an excellent performance horse with a record of producing top performers. Aspen is out of Whiskey Freckle, a granddaughter of AQHA Hall of Famer Freckles Playboy and Paddys Irish Whiskey. With her brilliant bloodlines and compact but strong build, Aspen will make a perfect reining or cutting horse prospect.

LOT 6 VT Watch Her Dualin

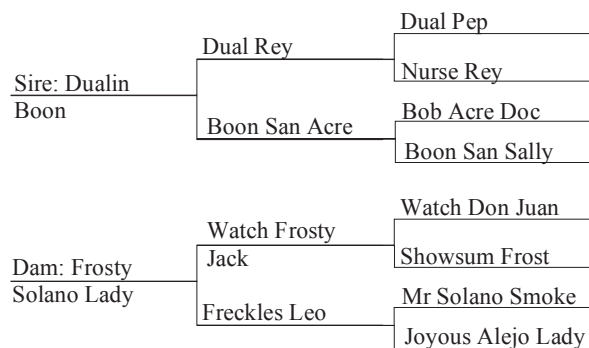

VT Watch Her Dualin, "Shasta", is a sharp 2016 sorrel filly by Dualin Boon a proven producer. On her dam's side, Shasta's pedigree traces back to a Watch Joe Jack, an AQHA Champion and a Superior Western Pleasure and Halter sire. This filly has the intelligence and disposition to pair with her build designed for the cutting horse ring.

*Registration Pending

LOT 7 VT Waltsin Around

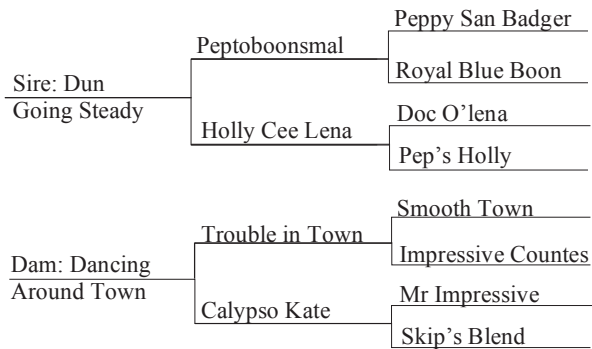

VT Waltsin Around, "Watson", is an inquisitive 2016 buckskin gelding out of Dancing Around Town, a mare whose lineage traces back to outstanding performance and halter horses such as Smooth Town and Mr Impressive, sires of World Champion offspring. Watson's sire Dun Going Steady, an ABRA World and Res. World Champion, has proven to produce wonderful all-around performance offspring with color. With his pleasurable gate and gorgeous color he is sure to stand out in the western pleasure show arena.

LOT 8 VT Wild N Wiskey

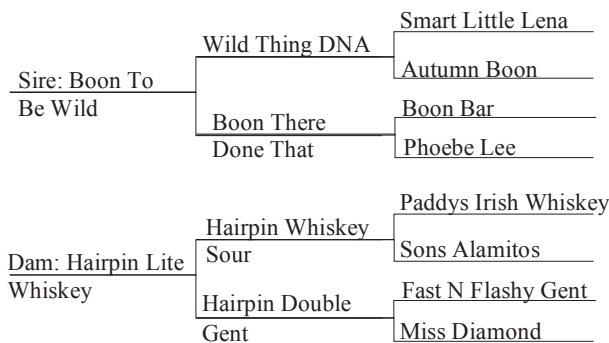

VT Wild N Whiskey, "Brandy", is a beautiful filly by the ROM earner Boon To Be Wild, son of Wild Thing DNA an earner of more than \$94K in the cutting pen and 40 performance points. Brandy's dam has produced several successful reined cow horses. Brandy displays a cadenced lope and natural head carriage. With Brandy's inquisitive personality and exceptional balance, she's sure to make an excellent cow horse prospect.

LOT 9 Augustus VT

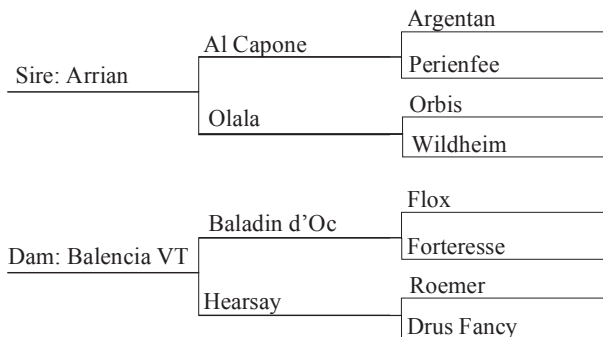

Augustus VT is a 2016 Oldenburg gelding with and elastic and uphill gaits. His dam, Balencia VT, is by Baladin d'Oc, a well-known French Anglo Arab producing winners at high levels of multiple disciplines, including dressage, jumping, and eventing. Augustus VT was outstanding at his inspection with impressive scores of 8.0 for movement, 7.8 for conformation and correctness, and an overall score of 7.9. His athleticism, movement, and temperament will enable Augustus VT to excel in any discipline.

LOT 10 SAWYER VT

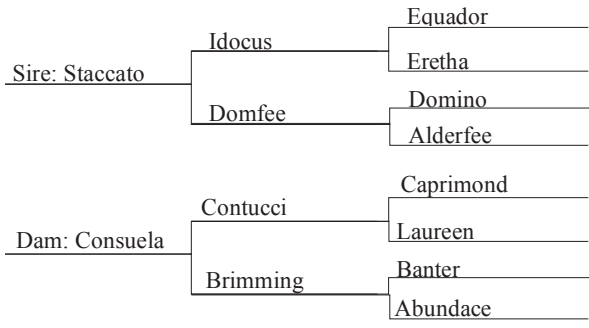

Sawyer VT is an exceptional 2015 Hanoverian gelding with lovely hack-winning movement, an amateur friendly temperament and correct conformation. His dam, Consuela, is a gorgeous mare from the proven Contucci-Banter cross who has had several premium foals and winning offspring. Her sire, Contucci, is a leading sire of USDF/Cosequin Breeders Championship and Dressage at Devon winners. Sawyer VT's sire, Staccato, has been Champion at Devon and Cosequin/USDF Breeders' Champion East Coast Finals. Staccato has earned a reputation of producing premium foals with willing attitudes and correct confirmation. With three lovely gaits and an especially cadenced and scopey canter, this youngster will win for you in whichever discipline you chose. Registered with the American Hanoverian Society.

LOT 11 ARTEMIS VT

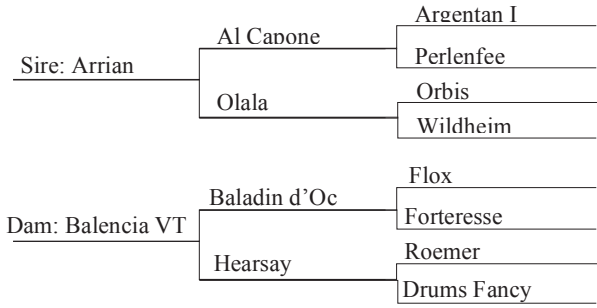

Pick your discipline with this big bodied attractive 2015 Hanoverian mare. Artemis VT is an "in your pocket" young horse whose kind and trainable nature, coupled with her flashy appearance, make her ideally suited to the show ring. Her dam, Balencia VT, is by Baladin d'Oc, a renowned French Anglo Arab, scoring an index of 91.9 at stallion test. His offspring have competed at high levels in dressage, show jumping, and eventing. Artemis VT is by Elite Hanoverian sire Arrian who comes from an impressive line of successful show jumpers. While her size and fancy markings first catch your eye, she follows it up with good movement and a winning personality. Registered with the American Hanoverian Society.

LOT 12 ROLLISON VT

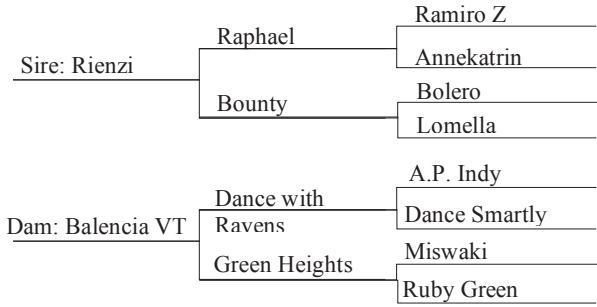

This correct and athletic 2015 Hanoverian X TB gelding has tons of presence and a great attitude. His dam, Glossy Ibis, is big and typey TB with an exceptional pedigree. His sire, Rienzi is an Elite Hanoverian well known for having a very sweet and personable temperament. He stamps his foals with excellent athleticism and rideability. Rollison VT has three lovely gates with plenty of scope. He is brave and bold, yet easy to handle and trainable. We are excited about his future in the show ring! Certificate of pedigree with the American Hanoverian Society.

LOT 13 DEFIANCE VT

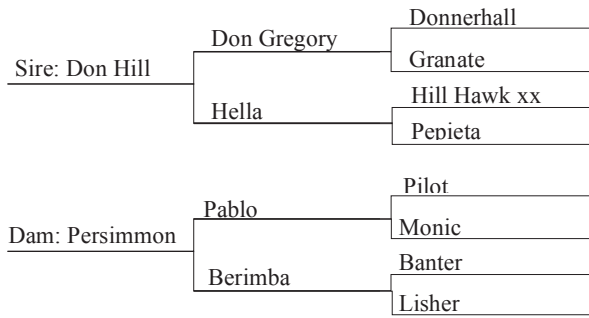

This fancy and athletic 2017 Hanoverian colt will stand out in any show ring. Defiance VT's dam, Persimmon, is from notable Hanoverian and Westphalian bloodlines. Her grandsire Pilot was one of the top show jumping sires of his time and her dam line is notable for success in dressage. His sire is the impressive Hanoverian Don Hill, who has produced several premium foals noted for their high scores for movement and he himself has competed through Prix St George. Defiance VT should be carefully considered by the serious competitor looking for their next champion. With his undeniable presence and jaw dropping movement, Defiance VT will be a serious competitor in any sport horse discipline. Registered with the American Hanoverian Society.

LOT 14 QURIOSITY VT

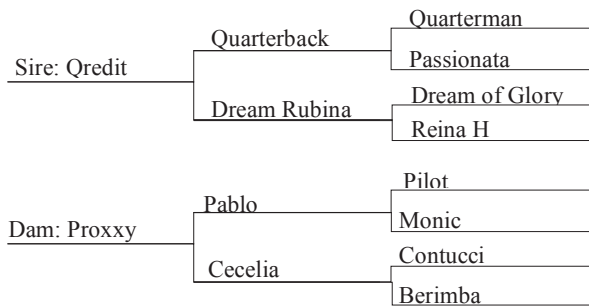

This fancy and athletic 2017 Hanoverian colt will stand out in any show ring. Defiance VT's dam, Persimmon, is from notable Hanoverian and Westphalian bloodlines. Her grandsire Pilot was one of the top show jumping sires of his time and her dam line is notable for success in dressage. His sire is the impressive Hanoverian Don Hill, who has produced several premium foals noted for their high scores for movement and he himself has competed through Prix St George. Defiance VT should be carefully considered by the serious competitor looking for their next champion. With his undeniable presence and jaw dropping movement, Defiance VT will be a serious competitor in any sport horse discipline. Registered with the American Hanoverian Society.

LOT 15 RAPPAHANNOCK VT

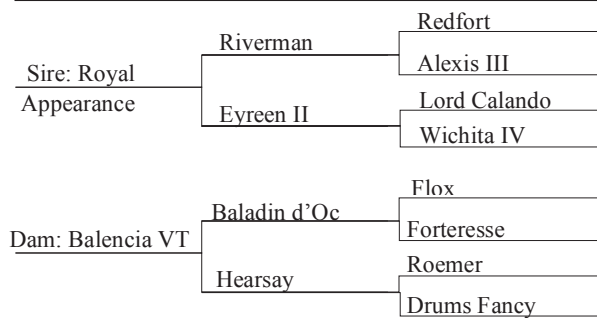

This smart and correct 2017 Hanoverian colt is quick to learn, well mannered, and displays three elastic and balanced gaits. Rappahannock VT is out of Balencia VT who has had several amateur friendly and successful foals. His sire, Royal Appearance, competed under Olympian Margie Goldstein-Engle and was Reserve Champion 6YO Jumper at the East Coast Finals. With a lovely disposition, athleticism and proven pedigree, Rappahannock VT displays the characteristics of a top performer. Registered with the American Hanoverian Society.

Reference Sires

Amber Pass 2001 Bay AQHA



Amber Pass, "Stan" is a maternal brother of All Inclusive, a Superior HUS and ROM Open Performance earner. Stan has excellent conformation and an outstanding temperament that is successfully passed on to his get. Out of the thoroughbred mare Maybelleni, daughter of Graded Stakes winner Amber Pass (Thoroughbred) and dam of multiple track winners, Stan displays a high degree of muscling with the light, floating movement of his Thoroughbred lineage. Stan has earned his Register of Merit in Hunter Under Saddle, Hunter Hack and Working Hunter. Virginia Tech is proudly offering two yearlings (Lot 1 & 2) by Amber Pass this year.

Boons Hired Hand 2004 Red Roan AQHA



Virginia Tech is proud to one yearlings (Lot 3) by Boons Hired Hand, "Boon". During his time standing at stud for the Virginia Tech breeding program, Boon produced numerous quality ranch type and reining stock. Boon's offspring display exceptional trainability and temperaments. Boon is the grandson of Pepto-boonsmal, a top cutting horse sire since 2001. Peptoboonsmal's progeny have won over \$20 million dollars, showing tremendous success across all disciplines. This yearling will be the last foal offered by Boons Hired Hand.

Pepto Cee Lena 2004 Black AQHA



Pepto Cee Lena, "Shaq" is sired by the infamous Peptoboonsmal whose offspring have earned more than \$25 million. Shaq is out of Holly Cee Lena a NCHA earner and NCHA producer of \$208,804. He is a beautiful black stallion that is structurally correct, athletic, and has a wonderful disposition. Shaq has proven his outstanding athleticism through an extensive show record. He is a NCHA money earner, AQHA Reserve World Champion Amateur Performance Halter, Open Performance ROM, Open Halter ROM, and point earner in performance halter, reining, working cow horse, and ranch. Shaq has also qualified for AQHA World Show every year from 2012-2016. Virginia Tech will proudly be offering one yearling gelding (Lot 4) by Pepto Cee Lena.

Dualin Boon 2001 Sorrel AQHA



Dualin Boon has a pedigree packed with excellent performance horses including his sire Dual Rey. Dual Rey, a NCHA money earner and Memphis Futurity 4YO OP Champion, is the sire of offspring earning \$26+ million. Dualin Boon is out of Boon San Acre, by Bob Acre Doc, an NCHA money earner and three time 4YO OP Futurity Finalist. Dualin Boon is an established performer earning over \$115,000 NCHA and was a finalist in multiple Futurities and Super Stakes. He has sired numerous NCHA Futurity Finalists with offspring earnings in excess of \$200,000. Dualin Boon's offspring have proven to be talented and trainable. The two fillies sired by Dualin Boon (Lot 5 & 6) offered by Virginia Tech are sure to have a bright future.

Dun Goin Steady 2003 Dun AQHA



Dun Goin Steady, "Tex" is a two time World Champion in Junior Western Pleasure. His sire, Rocked and Steady, is an outstanding sire with his offspring earning 1520+ performance pints, 22 Performance ROMS, 5 Superior Performance, 2 AQHA Champions, and 1130 IBHA Performance points in both western pleasure and hunter under saddle. Tex's dam Spring Rock Gold is a producer of successful All Around horses after being successful in the show ring herself. Tex has proven to produce talent as his offspring continue to rack up World Titles, NSBA Bronzes, ROM's, Futurity wins and National titles such as Washington State Horse of the Year in 2012 and winner of the Presidents Cup in 2013. VT will be offering one yearling (Lot 7) by Dun Goin Steady.

Boon To Be Wild 2004 Bay AQHA



Boon To Be Wild is an outstanding athlete with bloodlines to match. As a son of DNA Wild Thing (NCHA LTE \$94,561.45; P-40.5) and a maternal grandson of Boon Bar, Boon To Be Wild is bred for success. He has proven his athleticism by achieving a Register of Merit in both Working Cow Horse and Dally Team Roping as well as qualifying for the AHQA World Show. This year Virginia Tech is pleased to offer one quality two year old (Lot 4) by Boon To Be Wild. Any of these three are sure to make phenomenal working cow horse prospects.

Reference Sires

Staccato- 1999 | Black Dutch Warmblood Stallion | Idocus – Domino – Akrobat.

Approved ISR/Oldenburg N.A. and RPSI. In 2003 NA/WPN Keuring/Awarded Premium stallion. Sired by Idocus, a highly successful Grand Prix horse who won champion at Dressage at Devon as well as a World Cup Qualifier. Staccato competed in Dressage at I-1 level and in 2004 was the champion stallion at Devon as well as the Cosequin/ USDF Breeders Champion East Coast Finals in 2004. His progeny inherit his willing attitude, correct conformation and expressive movement. Virginia Tech proudly presents **Sawyer VT (Lot 10)** as a Staccato offspring. We thank Yolanda Williamson for donating the breeding.



Photo: SHN Payback

Arrian- 16.2h | 1992 | Bay Hanoverian Stallion | Al Capone – Orbis – Weiler.

Arrian "captivated his audience with his outstanding trot" at his 1994 Stallion licensing. In 1995, he was Young Horse Champion and winner of the Hanoverian Class at Port Jervis. In 1997 Arrian was Grand Champion at NEDA, where he received an overall score of 92%. Arrian's foal crops have also received official recognition. In 1996 the inspectors commented: "It is hard for us to imagine a better first foal crop for any young stallion". Virginia Tech proudly presents **Artemis VT (Lot 11)** as an Arrian offspring. We thank Maxine Mickel and Vanessa Carlson for donating the breeding.



Photo: Canterbury Court

Reinzi- 1994 | Chestnut Hanoverian Stallion | Raphael – Bolero – Lombard.

This elite stallion fully licensed for AHS after he was tested in the US in 1997. Rienzi is well known for having a very sweet and personable temperament as well as excellent paces with a strong, elastic back. He stamps his foals with excellent athleticism and rideability, producing good hunter and dressage prospects. Virginia Tech proudly offers **Rollison VT (Lot 12)** as a Rienzi offspring. We thank Maxine Mickel for donating the breeding.



Photo: Telos Farm

Don Hill- 16.0h | 1998 | Chestnut Hanoverian Stallion | Don Gregory – Hill Hawk xx – Pik Bube II.

Lifetime Approval based on 30-Day Test & Sport Record, Approved AHS, ISR/Oldenburg NA, & Rhineland. Don Hill has an uncomplicated character and has very comfortable gaits to ride, having successfully competed through Prix St. Georges. He is a moderate size, has a well-set neck, and a powerful hindquarter. At the 2014 Dressage at Devon, Don Hill offspring Don de Lion, Donhaela (ds. Hailo), and Drake (ds. Royal Prince) all earned top ten finishes. Virginia Tech proudly offer **Defiance VT (Lot 13)** as a Don Hill offspring. We thank Virginia Leary for donating the breeding.



Photo: Hilltop Farm

Qredit- 16.2h | 2008 | Chestnut Oldenburg Stallion | Quarterback – Dream of Glory – Rubinstein I.

Champion of 70-Day Stallion Test scoring 126.59 Total (135.93 Dressage, 113.16 Jumping); Received scores of 9 or higher for Character, Temperament, Constitution, Rideability, and all three gaits. Approved ISR/Old, GOV, AHS, Westphalian, & Rhineland. Qredit foals are known to inheriting their sire's movement and expression with numerous Premium Foals and Inspection Site Champion awards. In 2015, Qredit debuted at Prix St. Georges earning scores as high as 75%. Virginia Tech proudly offer **Curiosity VT (Lot 14)** as a Qredit offspring. We thank Hilltop Farm, Inc. for donating the breeding.



Photo: Hilltop Farm

Royal Appearance- 1995 | Grey Holsteiner Stallion | Riverman – Lord Calando – Othello.

Approved Stallion with ISR/Oldenburg. Finished 4th 100-Day Stallion Test with a total score of 121.16 (jumping index 118.44, dressage index 120.29) and was the only stallion to receive marks of 7 or higher in all categories, with 9's for character, willingness to work and ability to work. This earned him distinction as a Class I Stallion. In 2001, he achieved reserve champion of East Coast 6yr old Young Jumper Finals. His foal crops have been relatively small, but he has sired a high percentage of Premium foals and Inspection Site and Breed Show Champions. Virginia Tech proudly offer **Rappahannock VT (Lot 15)** as a Royal Appearance offspring.



Photo: Hilltop Farm



2017 Equine Behavior and Training Class

Back Row (L to R): Madison Gonzalez, Tanner Price, Kylie Ferrentino, Alicia Arneson, Lindsay Isernia, Larissa Brown, Halee Stroh, Carli Fischer, Clare Lynam

Front Row (L to R): Samantha Booth, Sonora Jamerson, Haylee Simpkins, Sharon Ford, Hanna Bartnick, Anna Fiorellino, Bibi Parlatore, Kristin Ward, Amber Koch

Not Present: Paige Altizer; **Instructors:** Beth Boteler-Sheely, Lisa Nulton; **TA:** Megan Strayer

Virginia Tech Beef Leadership Council

“The Beef Leadership Council strives to advocate for the beef industry, build relationships between producers and students, promote student leadership growth, and hopes to secure a positive future for agriculture and the beef industry.”



New this year!

Hokie Harvest Shirts, Stickers, and TWO Beef Quarters live auction!

This year the Council is auctioning two beef quarters at the beginning of the Hokie Harvest Sale! High quality beef is provided by Randy Kibler of Kibler Farms LLC, Edinburg, VA.

**Multiple Livestock
Equipment items for raffle!**

Long Sleeve Shirts \$15
Short Sleeve \$10
Stickers 3" x 5" - \$2

Shirt & Sticker Design ↓

Raffle Tickets are
\$10 each
or 3 for \$25

Tickets can be preordered & will be for sale at Hokie Harvest Sale. Call Gracie at (540)335-8566 to place your order!



OPTIMIZE YOUR HERD'S GENETIC POTENTIAL

SOUTHERN STATES® GENETIC EXPRESSION BEEF NUTRITION PROGRAM

FOR MORE INFORMATION,
VISIT
[SOUTHERNSTATES.COM/
GENETICEXPRESSION](http://SOUTHERNSTATES.COM/GENETICEXPRESSION)

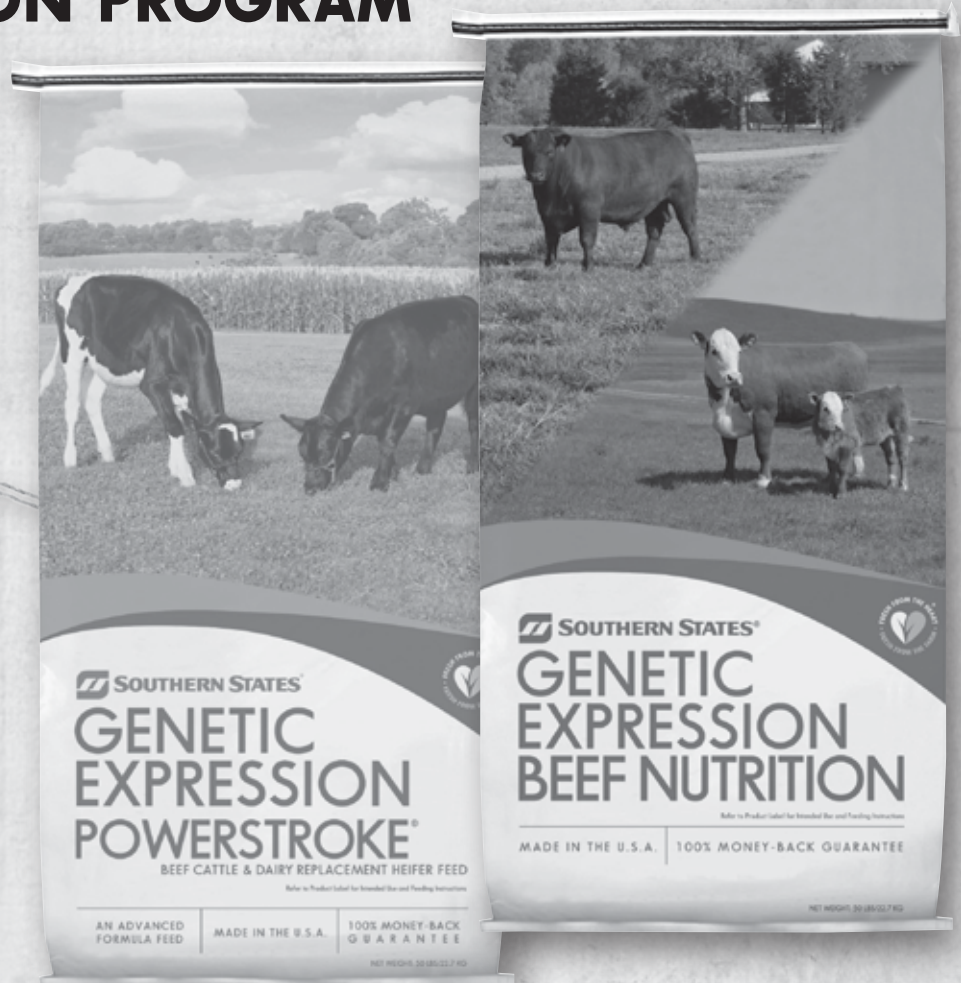

BUILD YOUR HERD POWER

- > Nutrition based on life stage and management needs
- > Can be hand-fed or self-fed to meet your management needs
- > Incorporates organic selenium, Zinpro Availa 4®, Intellibond® and yeast compounds to support gut health, immunity, reproduction and strong hooves

If you have questions or comments, please contact Feed Division Customer Service at ssfeedquestions@sscoop.com.

 **SOUTHERN STATES®**

Farmer owned since 1923.

SOUTHERNSTATES.COM



Loans for
*Farms, Homes,
Land &
Agribusiness!*



FARM CREDIT

800.919.FARM

FarmCreditofVirginias.com

 NMLS# 456965

LIVE INTERNET BIDDING AT www.cowbuyer.com

- Watch/bid in Real Time online.
- Registration is required. Please register at least one (1) hour prior to sale time at www.cowbuyer.com
- High Speed Internet is required. Slower speed will not permit you to bid and keep pace in real time.
- Terms: Purchasing online constitutes a legal contract and promise for payment of purchases. All purchases must be paid within ten (10) days of sale date and prior to load out or delivery of cattle purchased.
- Cowbuyer LLC is a service provider and is not responsible for the activity or inactivity of any technology, internet connection at the sale site or connection and technology of the bidders



Watch/Bid in Real Time Online at
www.cowbuyer.com

For questions or information, contact: Aaron Ray Tompkins – 336/363-4639, atompkin@vt.edu

*** Denotes Committee Chair*



Standing (L-R): (Sale Ring, Load-Out, and Clean-Up) - Richard Towell**, AJ Sheets, Trevor Smith, Trevor Brightwell, Brandon Loving, Jaret Tuck, Parker King, Bradley Cole, Wyatt Lotts, Zane Forbes, and Austin Revere (absent)
Kneeling (L-R): (Animal Display and Sale Prep) - Bailey Anderson, Tori Thornton, Jordan Conwell, Justin Light, Jenna Prater, Jessamy Thompson**, Jordan Alexander, Randall Gray, and Brady Louk
Sitting (L-R): (Decorations) - Emma Strouth, Teace Markwalter, Madalyn Fox**, Ashley Potter, Sierra Howell, Charles Johnson



Standing (L-R): (Food and Beverage) - Nikki Long**, Blake Smith, Graham Barker, Richard Luke Moore, Michael Yager, Keegan Czesak, Patrick Hall, Dylan Ellenburg, Eleanor Thompson, and Nicki Hardy
Kneeling (L-R): (Catalog and Social Media) - Cassandra Long, Alexa Johnson, Kylie Ferrentino, Sara Gordon**, Miranda Payne, Sydney Varney, and Michael Leonard
Sitting (L-R): (Advertising) - Zach Swope, Sydney Morgan, Linsey Dean**, and Chris Lower



Standing (L-R): (Clipping and Photography) - Emily Richardson, Taylor Carter, Taylor Kellerman, Antonia Villa, Abel Elwell, Joe D'Amato, Clare Lynam, Megan Strayer**, and Sarah Hughes
Kneeling (L-R): (Clerking) - Rachel Piepenbrink, Kaitlin Ciaston, William Minor, Lauren Beasley**, Becky Wilkins, Madison Goodman, and Brandy Harris
Sitting (L-R): (Registration) - Emily Nicely, Elizabeth Mullins**, Alyssa Goodwin, Kendra Phipps, Samantha Booth, and Jillian Ellermets



College of Agriculture
and Life Sciences

D. E. Eversole

Department of Animal and Poultry Sciences

University Exemplary Department
3440 Litton Reaves Hall (0306)
Blacksburg, Virginia 24061

FIRST CLASS MAIL

Presort First-Class
US Postage
PAID
Boelte-Hall LLC